

Mathematics

1983 - 2004

JAMB

Questions And Answers

Mathematics 1983

1. If M represents the median and D the mode of the measurements 5, 9, 3, 5, 8 then (M,D) is
 A. (6,5) B. (5,8) C. (5,7)
 D. (5,5) E. (7,5)
2. A construction company is owned by two partners X and Y and it is agreed that their profit will be divided in the ratio 4:5. at the end of the year. Y received #5,000 more than x. what is the total profit of the company for the year?
 A. #20,000.00 B. P*0#25,000.00 C. #30,000.00
 D. #15,000.003 E.#45,000.00
3. Given a regular hexagon, calculate each interior angle of the hexagon.
 A. 60^0 B. 30^0 C. 120^0
 D. 45^0 E. 135^0
4. Solve the following equations
 $4x - 3 = 3x + y = 2y + 5x - 12$
 A. $4x = 5, y = 2$ B. $x = 2, y = 5$ C. $x = -2, y = -5$
 D. $x = 5, y = -2$ E. $x = -5, y = -2$
5. If $x = 1$ is root of the equation $x^3 - 2x^2 - 5x + 6$, find the other roots
 A. -3 and 2 B. -2 and 2 C. 3 and -2
 D. 1 and 3 E. -3 and 1
6. If x is jointly proportional to the cube of y and the fourth power of z. In what ratio is x increased or decreased when y is halved and z is doubled?
 A. 4:1 increase B. 2:1 increase C. 1:4 decrease
 D. 1: 1 no change E. 3: 4 decrease
7. If $x = 1$ is root of the equation $x^3 - 2x^2 - 5x + 6$, find the other roots
 A. -3 and 2 B. -2 and 2 C. 3 and -2
 D. 1 and 3 E. -3 and 1
10. If $x + 2$ and $x - 1$ are factors of the expressions $lx + 2kx^2 + 24$, find the values of l and k
 A. $l = -6, k = -9$ B. $l = -2, k = 1$ C. $l = -2, k = -1$
 D. $l = 0, k = 1$ E. $l = 6, k = 0$
11. Make T the subject of the equation
 $\frac{av}{1-v} = 3\sqrt{\frac{v}{a} + \frac{T}{2T}}$
 A. $3av/(1-v)$ B. $2v(1-v)^2 - a^2v^2/2a^2v^2 - (1-v)^2$
 C. $2v(1-v)^2 + a^3v^2/2a^2v^2 + (1-v)^2$
 D. $2v(1-v)^2 - a^4v^3/2a^3v^3 - (1-v)^3$
 E. $2v(1-v)^3 - a^4v^3/2a^3v^3 + (1-v)^3$

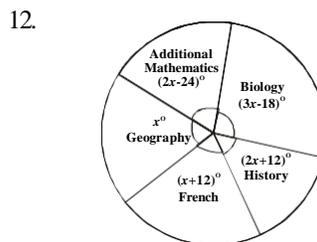

In a class of 60 pupils, the statistical distribution of the number of pupils offering Biology, History, French, Geography and Additional Mathematics is as shown in the pie chart above. How many pupils offer Additional Mathematics?

8. Given that $\cos z = L$, where z is an acute angle find an expression for $\frac{\cos z + \csc z}{\sec z + \tan z}$
 A. $\frac{1-L}{1+L}$ B. $\frac{L^2 - \sqrt{1-L^2}}{L^2 + L - 1}$ C. $\frac{-L - \sqrt{1-L}}{(C1+L) + \sqrt{1-L^2}}$
 D. $\frac{\sqrt{1-L}}{(L1+L^2) + \sqrt{1-L^2}}$ E. $\frac{L - (L^2 - 1)}{1 + \sqrt{1-L^2} + \sqrt{1-L^2}}$
9. If $0.0000152 \times 0.00042 = A \times 10^8$, where $1 \leq A < 10$, find A and B.
 A. $A = 9, B = 6.38$ B. $A = 6.38, B = -9$ C. $A = 6.38, B = 9$
 D. $A = 6.38, B = -1$ E. $A = 6.38, B = 1$
12. The value of $(0.303)^3 - (0.02)^3$ is
 A. 0.019 B. 0.0019 C. 0.00019
 D. 0.000019 E. 0.000035
13. y varies partly as the square of x and y partly as the inverse of the square root of x. write down the expression for y if $y = 2$ when $x = 1$ and $y = 6$ when $x = 4$
 A. $y = \frac{10x^2 + 52}{31 \cdot 31\sqrt{x}}$ B. $y = x^2 + \frac{1}{\sqrt{x}}$
 C. $y = x^2 + \frac{1}{x}$ D. $y = \frac{x^2 + 1}{31 \cdot 31\sqrt{x}}$ E. $y = \frac{10(x^2 + 1)}{31(\sqrt{x})}$
14. Simplify $(x-7)/(x^2-9) \cdot (x^2-3x)/(x^2-49)$
 A. $x/(x-3)(x+7)$ B. $(x+3)(x+7)/x$ C. $x/(x-3)(x-7)$
 D. $x/(x+3)(x+7)$ E. $x/(x+4)(x+7)$
15. The lengths of the sides of a right-angled triangle at $(3x + 1)$ cm, $(3x - 1)$ cm and x cm.
 A. 2 B. 6 C. 18
 D. 12 E. 0
16. The scores of a set of a final year students in the first semester examination in a paper are 41,29,55,21,47,70,70,40,43,56,73,23,50,50. find the median of the scores.
 A. 47 B. $48\frac{1}{2}$ C. 50
 D. 48 E. 49

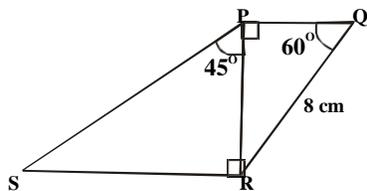

In the above figure $\angle PQR = 60^0$, $\angle QPR = 90^0$, $\angle PRS = 90^0$, $\angle RPS = 45^0$, $QR = 8$ cm. Determine PS
 A. $2\sqrt{3}$ cm B. $4\sqrt{6}$ cm C. $2\sqrt{6}$ cm
 D. $8\sqrt{6}$ cm E. 8cm

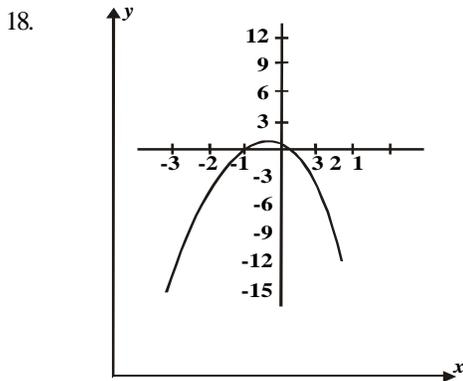

18.

Which of the following equations represents the above graph?

- A. $y = 1 + 2x + 3x^2$ B. $y = 1 - 2x + 3x^2$ C. $y = 1 + 2x - 3x^2$
 D. $y = 1 - 2x - 3x^2$ E. $y = 3x^2 + 2x - 1$

19.

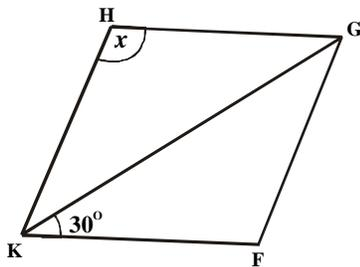

The above figure FGHK is a rhombus. What is the value of the angle x ?

- A. 90° B. 30° C. 150°
 D. 120° E. 60°

20.

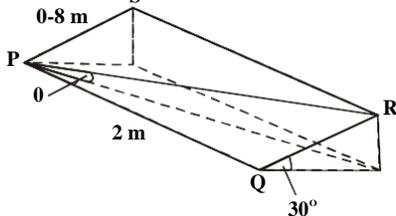

PQRS is a desk of dimensions $2\text{m} \times 0.8\text{m}$ which is inclined at 30° to the horizontal. Find the inclination of the diagonal PR to the horizontal.

- A. $23^\circ 35'$ B. 30° C. $15^\circ 36'$
 D. 10° E. $10^\circ 42'$

21.

Find x if $(x_{\text{base } 4})^2 = 100_{\text{base } 2}$

- A. 6 B. 12 C. 100
 D. 210 E. 110

22.

Simplify $\log_{10} a^{1/2} + 1/4 \log_{10} a - 1/12 \log_{10} a^7$

- A. 1 B. $7/6 \log_{10} a$ C. 0
 D. 10 E. a

23.

If w varies inversely as V and u varies directly as w^3 , find the relationship between u and V given that $u = 1$, when $V = 2$

- A. $u = 8V^3$ B. $u = 2\sqrt{V}$ C. $V = 8/u^2$
 D. $V = 8u^2$ E. $U = 8/v^3$

24.

Solve the simultaneous equations for x

$$\begin{aligned} x^2 + y - 8 &= 0 \\ y + 5x - 2 &= 0 \end{aligned}$$

- A. -28,7 B. 6,-28 C. 6,-1
 D. -1,7 E. 3,2

25.

Find the missing value in the following table.

x	-2	-1	0	1	2	3
$y = x^9 - x + 3$		3	3	3	9	27

- A. -3 B. 3 C. -9
 D. 13 E. 9

26.

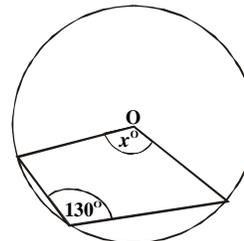

If O is the centre of the circle in the figure above. Find the value of x

- A. 50 B. 260 C. 100
 D. 65 E. 130

27.

Find the angle of the sectors representing each item in a pie chart of the following data. 6,10,14,16,26

- A. $15^\circ, 25^\circ, 35^\circ, 40^\circ, 65^\circ$ B. $60^\circ, 100^\circ, 140^\circ, 160^\circ, 260^\circ$
 C. $6^\circ, 10^\circ, 14^\circ, 16^\circ, 26^\circ$ D. $30^\circ, 50^\circ, 70^\circ, 80^\circ, 130^\circ$
 E. None of the above

28.

The scores of 16 students in a Mathematics test are 65,65,55,60,60,65,60,70,75,70,65,70,60,65,65,70

What is the sum of the median and modal scores?

- A. 125 B. 130 C. 140
 D. 150 E. 137.5

29.

The letters of the word MATRICULATION are cut and put into a box. One of the letter is drawn at random from the box. Find the probability of drawing a vowel.

- A. $2/13$ B. $5/13$ C. $6/13$
 D. $8/13$ E. $4/13$

30.

Correct each of the number 59.81789 and 0.0746829 to three significant figures and multiply them, giving your answer to three significant figures.

- A. 4.46 B. 4.48 C. 4.47
 D. 4.49 E. 4.50

31.

If a rod of length 250cm is measured as 255cm longer in error, what is the percentage error in measurement?

- A. 55 B. 10 C. 5
 D. 4 E. 2

32.

If $(2/3)m(3/4)n = 256/729$, find the values of m and n

- A. $m=4, n=2$ B. $m=-4, n=-2$ C. $m=-4, n=2$
 D. $m=4, n=-2$ E. $m=-2, n=4$

33.

Without using tables find the numerical value of $\log_4 49 + \log_7 (1/7)$

- A. 1 B. 2 C. 3
 D. 7 E. 0

34. Factorize completely $81a^4 - 16b^4$
- $(3a + 2b)(2a - 3b)(9a^2 + 4b^2)$
 - $(3a - 2b)(2a - 3b)(4a^2 - 9b^2)$
 - $(3a - 2b)(3a - 2b)(9a^2 + 4b^2)$
 - $(3a - 2b)(2a - 3b)(9a^2 + 4b^2)$
 - $(3a - 2b)(2a - 3b)(9a^2 - 4b^2)$

35. One interior angle of a convex hexagon is 170° and each of the remaining interior angles is equal to x° . find x
- 120°
 - 110°
 - 105°
 - 102°
 - 100°

36. PQRS is a cyclic quadrilateral in which $PQ = PS$. PT is a tangent to the circle and PQ makes an angle 50° with the tangent as shown in the figure below. What is the size of $\angle QRS$?

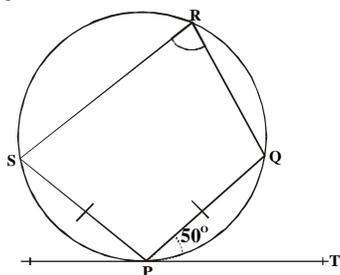

- 50°
- 40°
- 110°
- 80°
- 100°

37. A ship H leaves a port P and sails 30km due South. Then it sails 60km due west. What is the bearing of H from P?
- $26^\circ 34'$
 - $243^\circ 26'$
 - $116^\circ 34'$
 - $63^\circ 26'$
 - 240°

38. In a sample survey of a university community the following table shows the percentage distribution of the number of members per household.

No of members per household	1	2	3	4	5	6	7	8	Total
Number of households	3	12	15	28	21	10	7	4	100

- 4
- 3
- 5
- 4.5
- None

39. On a square paper of length 2.524375cm is inscribed a square diagram of length 0.524375. find the area of the paper not covered by the diagram correct to 3 significant figures.
- 6.00cm^2
 - 6.10cm^2
 - 6cm^2
 - 6.09cm^2
 - 4.00cm^2

40. If $f(x) = \frac{1}{x-1} + \frac{x-1}{x^2-1}$ find $f(1-x)$

- $\frac{1}{x} + \frac{1}{(x+2)}$
- $x + \frac{1}{(2x-1)}$
- $-\frac{1}{x} - \frac{1}{(x-2)}$
- $-\frac{1}{x} + \frac{1}{(x^2-1)}$

41. In the figure below find $\angle PRQ$

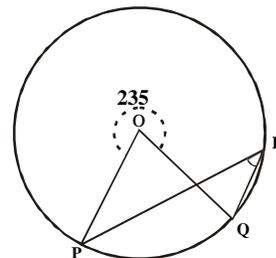

- $66\frac{1}{2}^\circ$
- $62\frac{1}{2}^\circ$
- 125°
- 105°
- 65°

42. Simplify $\frac{7a^9}{8}$

- $\frac{9a^2}{2}$
- $\frac{9a^3}{2}$
- $\frac{2}{3a^2}$
- $\frac{2}{3a^2}$
- $\frac{3a^3}{2}$

- 43.

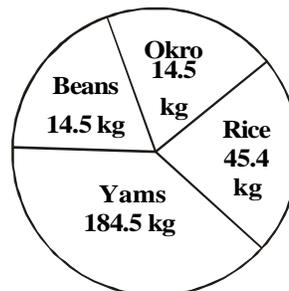

The farm yields of four crops on a piece of land in Ondo are represented on the pie chart above. What is the angle of the sector occupied by Okro in the chart?

- $91\frac{1}{2}^\circ$
- $19\frac{1}{3}^\circ$
- $33\frac{1}{3}^\circ$
- 11°
- 91°

- 44.

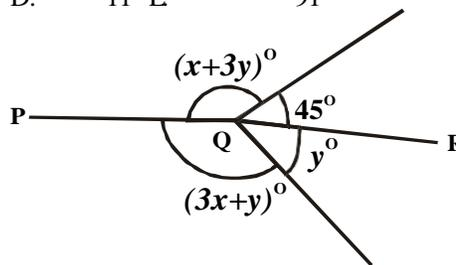

In the figure above, PQR is a straight line. Find the values of x and y

- $x = 22.5^\circ$ and $y = 33.75^\circ$
- $x = 15^\circ$ and $y = 52.5^\circ$
- $x = 22.5^\circ$ and $y = 45.0^\circ$
- $x = 56.25^\circ$ and $y = 11.5^\circ$
- $x = 18.0^\circ$ and $y = 56.5^\circ$

45. PQR is the diameter of a semicircle RSP with centre at Q and radius of length 3.5cm. if $\angle PQT = \angle QRT = 60^\circ$. Find the perimeter of the figure (PTRS) $p = \frac{22}{7}$

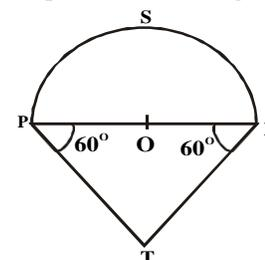

- 25cm
- 18cm
- 36cm
- 29cm
- 25.5 cm

46. In a triangle PQR, QR = 3cm, PR = $3\sqrt{3}$ cm, PQ = $3\sqrt{3}$ cm and $\angle Q = 30^\circ$. find angles P and R
 A. $\angle P = 60^\circ$ and $\angle R = 90^\circ$
 B. $\angle P = 30^\circ$ and $\angle R = 120^\circ$
 C. $\angle P = 90^\circ$ and $\angle R = 60^\circ$
 D. $\angle P = 60^\circ$ and $\angle R = 60^\circ$
 E. $\angle P = 45^\circ$ and $\angle R = 105^\circ$

47.

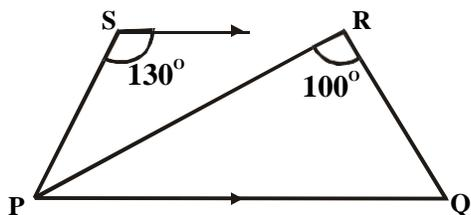

In the above diagram if PS = SR and PQ // SR. what is the size of $\angle PQR$?

- A. 25° B. 50° C. 55°
 D. 65° E. 75°
48. Find the mean of the following
 24.57, 25.63, 25.32, 26.01, 25.77
 A. 25.12 B. 25.30 C. 25.26
 D. 25.50q E. 25.73

49.

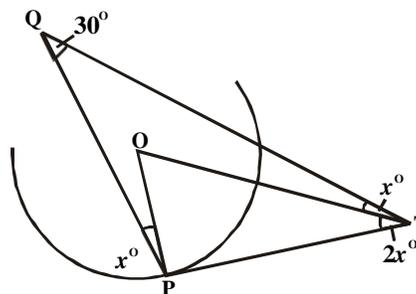

In the figure above PT is a tangent to the circle with centre O. if $\angle PQT = 30^\circ$. find the value of $\angle PTO$

- A. 30° B. 15° C. 24°
 D. 12° E. 60°

50

A man drove for 4 hours at a certain speed, he then doubled his speed and drove for another 3 hours. Altogether he covered 600km. At what speed did he drive for the last 3 hours?

- A. 120km/hr B. 60km/hr C. 600/7km/hr
 D. 50km/hr E. 100km/hr.

Mathematics 1984

1. Simplify $(\frac{2}{3} - \frac{1}{5}) - \frac{1}{3}$ of $\frac{2}{5}$
 A. $\frac{1}{7}$ B. $\frac{7}{3}$ C. $\frac{1}{3}$
 D. $\frac{3}{7}$ E. $\frac{1}{5}$
2. If $263 + 441 = 714$, what number base has been used?
 A. 12 B. 11 C. 10
 D. 9 E. 8
3. $0.00014323 / 1.940000 = k \times 10^n$ where $1 \leq k < 10$ and n is a whole number. The values of K and n are
 A. 7.381 and -11 B. 2.34 and 10
 C. 3.87 and 2 D. 7.831 and -11
 E. 5.41 and -2
4. P sold his bicycle to Q at a profit of 10%. Q sold it to R for #209 at a loss of 5%. How much did the bicycle cost P?
 A. #200 B. #196 C. #180
 D. #205 E. #150
5. If the price of oranges was raised by $\frac{1}{2}k$ per orange, the number of oranges customer can buy for #2.40 will be less by 16. What is the present price of an orange?
 A. $2\frac{1}{2}k$ B. $3\frac{1}{2}k$ C. $5\frac{1}{2}k$
 D. $20k$ E. $21\frac{1}{2}k$

6. A man invested a total of #50,000 in two companies. If these companies pay dividend of 6% and 8% respectively, how much did he invest at 8% if the total yield is #3,700?
 A. #15,000 B. #29,600 C. #21,400
 D. #27,800 E. #35,000
7. Thirty boys and x girls sat for a test. The mean of the boys' scores and that of the girls were respectively 6 and 8. find x if the total score was 468.
 A. 38 B. 24 C. 36
 D. 22 E. 41
8. The cost of production of an article is made up as follows
- | | |
|---------------|-----|
| Labour | #70 |
| Power | #15 |
| Materials | #30 |
| Miscellaneous | #5 |
- Find the angle of the sector representing labour in a pie chart.
 A. 210° B. 105° C. 175°
 D. 150° E. 90°
9. Bola chooses at random a number between 1 and 300. What is the probability that the number is divisible by 4?
 A. $\frac{1}{3}$ B. $\frac{1}{4}$ C. $\frac{1}{5}$
 D. $\frac{4}{300}$ E. $\frac{1}{300}$

10. Find without using logarithm tables, the value of $\frac{\log_3 27 - \log_{1/4} 64}{\log_3 1/81}$
- A. $7/4$ B. $-7/4$ C. $-3/2$
D. $7/3$ E. $-1/4$
11. A variable point P(x, y) traces a graph in a two dimensional plane. (0, -3) is one position of P. If x increases by 1 unit, y increases by 4 units. The equation of the graph is
- A. $-3 = y + 4/x + 1$ B. $4y = -3 + x$
C. $y/x = -3/4$ D. $y + 3 = 4x$
E. $4y = x + 3$
12. A trader in a country where their currency 'MONT' (M) is in base five bought $103_{(5)}$ oranges at $M14_{(5)}$ each. If he sold the oranges at $M24_{(5)}$ each, what will be his gain?
- A. $M103_{(5)}$ B. $M1030_{(5)}$ C. $M102_{(5)}$
D. $M2002_{(5)}$ E. $M3032_{(5)}$
13. Rationalize $\frac{(5\sqrt{5} - 7\sqrt{5})(\sqrt{7} - \sqrt{5})}{4\sqrt{7} - 6\sqrt{5}}$
- A. $-2\sqrt{35}$ B. $4\sqrt{7} - 6\sqrt{5}$ C. $-\sqrt{35}$
D. $4\sqrt{7} - 8\sqrt{5}$ E. $\sqrt{35}$
14. Simplify $\frac{3^3 \times 3^{n-1} - 27 \times 3^{n-1}}{3^n - 3^{n-1}}$
- A. 1 B. 0 C. $1/27$
D. $3^n - 3^{n-1}$ E. $2/27$
15. p varies directly as the square of q and inversely as r. if $p = 36$, when $q = 3$ and $r = p$, find p when $q = 5$ and $r = 2$
- A. 72 B. 100 C. 90
D. 200 E. 125
16. Factorise $6x^2 - 14x - 12$
- A. $2(x + 3)(3x - 2)$ B. $6(x - 2)(x + 1)$
C. $2(x - 3)(3x + 2)$ D. $6(x + 2)(x - 1)$
E. $(3x + 4)(2x + 3)$
17. A straight line $y = mx$ meets the curve $y = x^2 - 12x + 40$ in two distinct points. If one of them is (5,5), find the other
- A. (5,6) B. (8,8) C. (8,5)
D. (7,7) E. (7,5)
18. The table below is drawn for a graph $y = x^2 - 3x + 1$

x	-3	-2	-1	0	1	2	3
$y = x^2 - 3x + 1$	1	-1	3	1	-1	3	1

From $x = -2$ to $x = 1$, the graph crosses the x-axis in the range(s)

- A. $-1 < x < 0$ and $0 < x < 1$
B. $-2 < x < -1$ and $0 < x < 1$
C. $-2 < x < -1$ and $0 < x < 1$
D. $0 < x < 1$ E. $1 < x < 2$

19. In a racing competition. Musa covered a distance of 5xkm in the first hour and $(x + 10)$ km in the next hour. He was second to Ngozi who covered a total distance of 118km in the two hours. Which of the following inequalities is correct?

- A. $0 < -x < 15$ B. $-3 < x < 3$
C. $15 < x < 18$ D. $0 < x < 15$
E. $0 < x < 18$

20. $2x + 3y = 1$ and $y = x - 2y = 11$, find $(x + y)$

- A. 5 B. -3 C. 8
D. 2 E. 2

21. Tunde and Shola can do a piece of work in 18 days. Tunde can do it alone in x days, whilst Shola takes 15 days longer to do it alone. Which of the following equations is satisfied by x?

- A. $x^2 - 5x - 18 = 0$ B. $x^2 - 20x + 360 = 0$
C. $x^2 - 21x - 270 = 0$ D. $2x^2 + 42x - 190 = 0$
E. $3x^2 - 31x + 150 = 0$

22. If $fx = 2(x - 3)2 + 3(x - 3) - 4$ and $g(y) = \sqrt{5} + y$, find $g(f(3))$ and $g\{f(4)\}$

- A. 3 and 4 B. -3 and 4
C. -3 and -4 D. 3 and -4
E. 0 and $\sqrt{5}$

23. The quadratic equation whose roots are $1 + \sqrt{13}$ and $1 + \sqrt{13}$ is

- A. $x^2 + (1 - \sqrt{13})x + 1 + \sqrt{13} = 0$
B. $x^2 + (1 - \sqrt{13})x + 1 - \sqrt{13} = 0$
C. $x^2 + 2x + 12 = 0$ D. $x^2 - 2x + 12 = 0$
E. $x^2 - 2x - 12 = 0$

24. Find a factor which is common to all three binomial expressions

- $4a^2 - 9b^2, a^3 + 27b^3, (4a + 6b)^2$
- A. $4a + 6b$ B. $4a - 6b$
C. $2a + 3b$ D. $2a - 3b$
E. none

- 25.

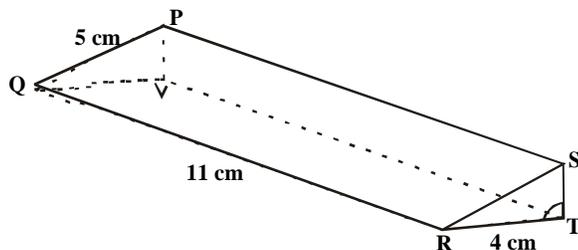

What is the volume of the regular three dimensional figure drawn above?

- A. 160cm^3 B. 48cm^3 C. 96cm^3
D. 120cm^3 E. 40cm^3

26. If $(x - 2)$ and $(x + 1)$ are factors of the expression $x^3 + px^2 + qx + 1$, what is the sum of p and q?

- A. 0 B. -3 C. 3
D. $-17/3$ E. $-2/3$

27. A cone is formed by bending a sector of a circle having an angle of 210° . Find the radius of the base of the cone if the diameter of the circle is base of the cone if the diameter of the circle is 12cm
 A. 7.00cm B. 1.75cm C. $\frac{1}{2}$ cm
 D. 3.50cm E. $2\frac{1}{2}$ cm

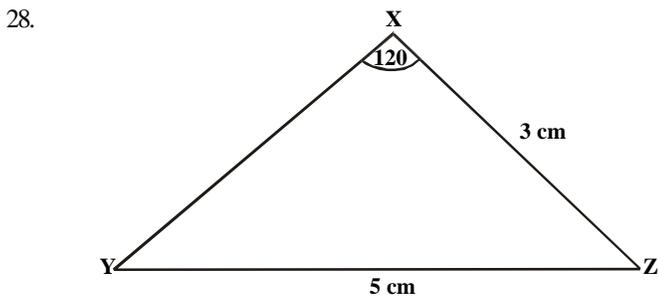

- Using $\triangle XYZ$ in the figure above find $\angle XYZ$
 A. 29° B. $31^\circ 20'$ C. 31°
 D. $31^\circ 18'$ E. 59°

29. The sides of a triangle are $(x + 4)$ cm, x cm and $(x - 4)$ cm respectively. If the cosine of the largest angle is $\frac{1}{5}$, find the value of x
 A. 24cm B. 20cm C. 28cm
 D. $\frac{88}{7}$ cm E. 0cm

30. If $a = \frac{2x}{1-x}$ and $b = \frac{1+x}{1-x}$ then $a^2 - b^2$ in the simplest form is
 A. $\frac{3x+1}{(x-1)}$ B. $\frac{3x^2-1}{(x-1)^2}$
 C. $\frac{3x^2+1}{(1-x)^2}$ D. $\frac{5x^2-1}{(1-x)^2}$
 E. $\frac{5x^2-2x-1}{(1-x)^2}$

31. Simplify $(1 + \frac{x-1}{x+1})(x+2)$
 A. $\frac{(x^2 - 1)(x + 2)}{x + 1}$ B. $\frac{x^2(x + 2)}{x + 1}$
 C. $\frac{x^2 - (x + 2)}{x + 1}$ D. $\frac{2x(x + 2)}{x + 1}$
 E. $\frac{2x(x + 2)}{x + 1}$

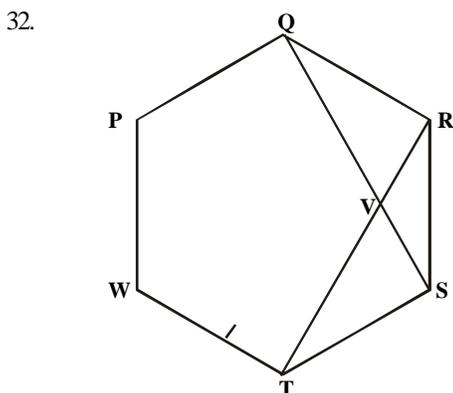

- In the figure above PQRSTW is a regular hexagon. QS intersects RT at V. calculate $\angle TVS$.
 A. 60° B. 90° C. 120°
 D. 30° E. 80°

33. Find the integral values of x which satisfy the inequalities $-3 < 2 - 5x < 12$
 A. -2, -1 B. -2, 2 C. -1, 0
 D. 0, 1 E. 1, 2

34.

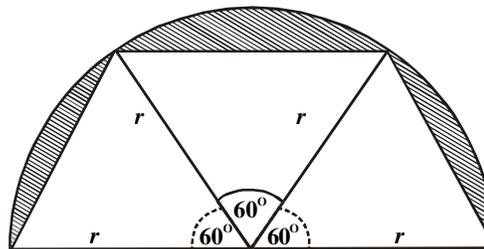

Find the area of the shaded portion of the semi-circular figure above.

- A. $\frac{r^2}{4}(4p - 3\sqrt{3})$ B. $\frac{r^2}{4}(2p + 3\sqrt{3})$
 C. $\frac{1}{2}r^2p$ D. $\frac{1}{8}r^2p$
 E. $\frac{r^2}{8}(4p + 3\sqrt{3})$

35.

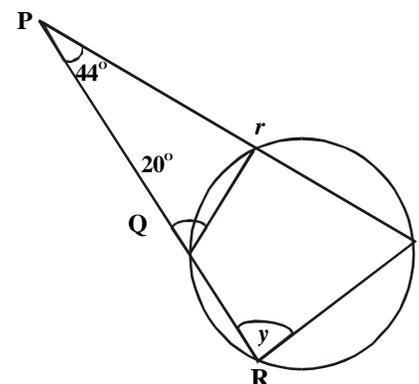

In the figure above QRS is a line, $\angle PSQ = 35^\circ$ $\angle SPR = 30^\circ$ and O is the centre of the circle find $\angle QOP$

- A. 35° B. 30° C. 130°
 D. 25° E. 65°

36.

If $pq + 1 = q^2$ and $t = \frac{1}{p} - \frac{1}{pq}$ express t in terms of q

- A. $\frac{1}{p} - q$ B. $\frac{1}{q} - 1$
 C. $\frac{1}{q} + 1$ D. $1 + q$
 E. $\frac{1}{1 - q}$

37.

The cumulative frequency function of the data below is given by the frequency $y = cf(x)$. what is $cf(5)$?

Scores(n)	Frequency(f)
3	30
4	32
5	30
6	35
7	20

- A. 30 B. 35 C. 55
 D. 62 E. 92

38.

In the figure determine the angle marked y

- A. 66° B. 110° C. 26°
 D. 70° E. 44°

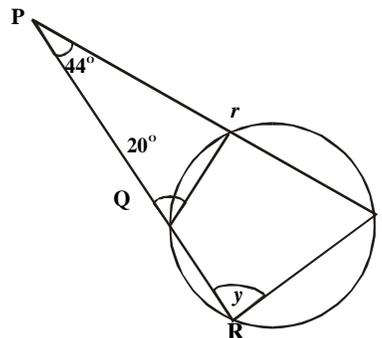

39. A right circular cone has a base radius r cm and a vertical height $2y^0$. the height of the cone is
 A. $r \tan y^0$ cm B. $r \sin y^0$ cm
 C. $r \cot y^0$ cm D. $r \cos y^0$ cm
 E. $r \operatorname{cosec} y^0$ cm
40. Two fair dice are rolled. What is the probability that both show up the same number of point?
 A. $1/36$ B. $7/36$ C. $1/2$
 D. $1/3$ E. $1/6$

41. The larger value of y for which $(y - 1)^2 = 4y - 7$ is
 A. 2 B. 4 C. 6
 D. 7 E. 8

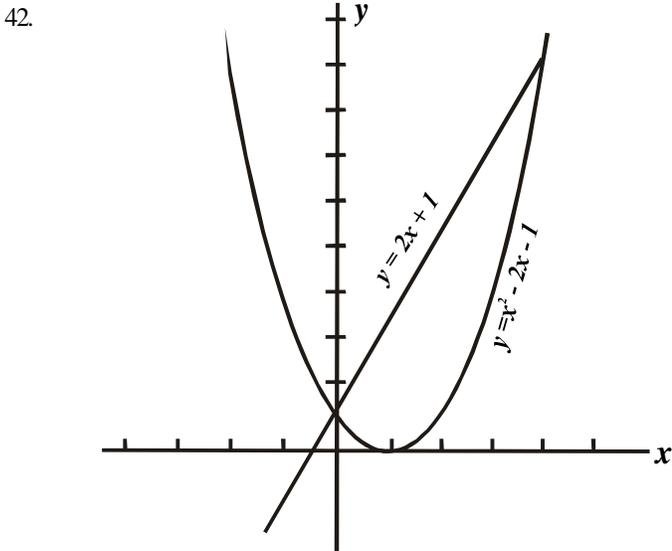

Find the x coordinates of the points of intersection of the two equations in the graph above.

- A. 1,1 B. 0,-4 C. 4,9
 D. 0,0 E. 0,4
43. If $\sin q = x/y$ and $0^\circ < q < 90^\circ$ then find $1/\tan q$
 A. $x/\sqrt{(y^2 - x^2)}$ B. x/y
 C. $\frac{\sqrt{y^2 - x^2}}{\sqrt{y^2 - x^2}}$ D. $(\sqrt{y^2 - x^2})/(\sqrt{y^2 - x^2})$
 E. $\frac{\sqrt{y^2 - x^2}}{\sqrt{y^2 - x^2}y}$

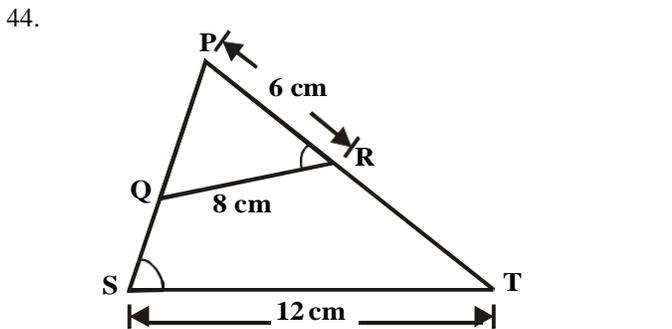

In the figure above $TSP = PRQ$, $QR = 8$ cm. $PR = 6$ cm and $ST = 12$ cm. Find the length SP

- A. 4cm B. 16cm C. 9cm
 D. 14cm E. Impossible insufficient data

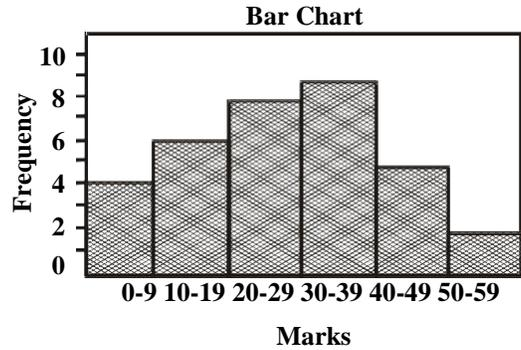

The bar chart above shows the mark distribution in a class test. Find the number of students in the class.

- A. 9 B. 2 C. 60
 D. 30 E. 34

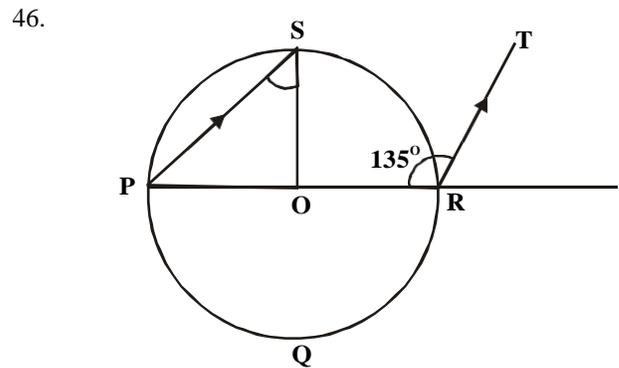

In the figure above, O is the centre of circle $PQRS$ and $PS \parallel RT$. If $\angle PRT = 135^\circ$, then $\angle PSQ$ is

- A. $67\frac{1}{2}^\circ$ B. 45° C. 90°
 D. $33\frac{3}{4}^\circ$ E. $22\frac{1}{2}^\circ$

47. XYZ is a triangle and XW is perpendicular to YZ at W . if $XZ = 5$ cm and $WZ = 4$ cm, calculate XY .

- A. $5\sqrt{3}$ cm B. $3\sqrt{5}$ cm C. $3\sqrt{3}$ cm
 D. 5cm E. 6cm

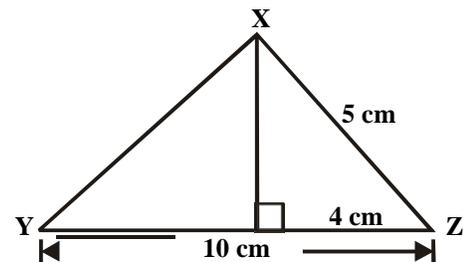

48. Measurements of the diameters in centimeters of 20 copper spheres are distributed as shown below

Class boundary in cm	frequency
3.35-3.45	3
3.45-3.55	6
3.55-3.65	7
3.65-3.75	4

What is the mean diameter of the copper sphere?

- A. 3.40cm B. 3.58cm C. 3.56cm
 D. 3.62cm E. 3.63cm

Use the instruction below to answer question 49 and 50

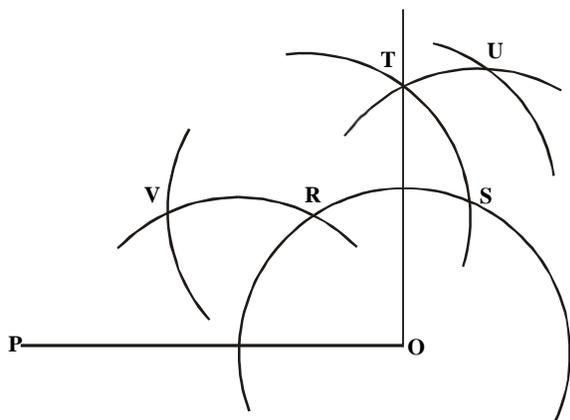

49. What is the obtuse angle formed when the point U is joined to Q?
 A. 75° B. 154° C. 120°
 D. 105° E. 125°
50. What is the acute angle formed when the point V is joined to Q?
 A. 60° B. 30° C. 45°
 D. 90° E. 15°

Mathematics 1985

1. Arrange the following numbers in ascending order of magnitude $6/7, 13/15, 0.865$
 A. $6/7 < 0.865 < 13/15$
 B. $6/7 < 13/15 < 0.865$
 C. $13/15 < 6/7 < 0.865$
 D. $13/15 < 0.865 < 6/7$
 E. $0.865 < 6/7 < 13/15$
2. A sum of money was invested at 8% per annum simple interest. If after 4 years the money amounts to #330.00, find the amount originally invested.
 A. #180.00 B. #165.00 C. #150.00
 D. #200.00 E. #250.00
3. In the equation below, solve for x if all the numbers are in base 2? $11/x = 1000/(x + 101)$
 A. 101 B. 11 C. 110
 D. 111 E. 10
4. List all integers satisfying the inequality $-2 < 2x - 6 < 4$
 A. 2,3,4,5 B. 2,3,4 C. 2,5
 D. 3,4,5 E. 4,5
5. Find correct to two decimal places $100 + 1/100 + 3/1000 + 27/10000$
 A. 100.02 B. 1000.02
 C. 100.22 D. 100.01
 E. 100.51
6. Simplify $1/2 + \frac{1}{2 + \frac{1}{2 - \frac{1}{4 + 1/5}}}$
 A. $3/4$ B. $-1/3$ C. $169/190$
 D. $13/15$ E. $1^{21}/_{169}$
7. If three numbers p, q, r are in the ratio 6:4:5 find the value of $(3q - q)/(4q + r)$
 A. $3/2$ B. $2/3$ C. 2
 D. 3 E. 18
8. Without using tables, evaluate $\text{Log}_2 4 + \text{Log}_4 2 - \text{Log}_{25} 5$
 A. $1/2$ B. $1/5$ C. 0
 D. 5 E. 2
9. John gives one third of his money to Janet who has #105.00. He then finds that his money is reduced to one-fourth of what Janet now has. Find how much money John had at first.
 A. #45.00 B. #48.00 C. #52.00
 D. #58.00 E. #60.00
10. Find x if $\text{Log}_9 x = 1.5$
 A. 72.0 B. 27.0 C. 36.0
 D. 3.5 E. 24.5
11. Write h in terms of a = $\frac{b(1 - ch)}{(1 - dh)}$
 A. $h = \frac{(a - b)}{(ad - bc)}$ B. $h = \frac{(a + b)}{(ad - bc)}$
 C. $h = \frac{(ad - bc)}{(a - b)}$ D. $h = \frac{(1 - b)}{(d - bc)}$
 E. $h = \frac{(b - a)}{(ad - bc)}$
12. $22\frac{1}{2}\%$ of the Nigerian Naira is equal to $17\frac{1}{10}\%$ of a foreign currency M. what is the conversion rate of the M to the Naira?
 A. $1M = \frac{15}{57}N$ B. $1M = 2\frac{11}{57}N$
 C. $1M = 1\frac{18}{57}N$ D. $1M = 38\frac{1}{4}N$
 E. $1M = 384\frac{3}{4}N$
13. Find the values of p for which the equation $x^2 - (p - 2)x + 2p + 1 = 0$ has equal roots
 A. (0,12) B. (1,2) C. (21,0)
 D. (4,5) E. (3,4)

14. If $e^x = 1 + x + \frac{x^2}{2!} + \frac{x^3}{3!} + \dots$ find $1/e^{12}$
 A. $1 - \frac{x}{2} + \frac{x^2}{12} - \frac{x^3}{24} + \dots$ B. $1 + \frac{x}{2} + \frac{x^2}{12} + \frac{x^3}{24} + \dots$
 C. $1 + \frac{x}{2} + \frac{x^2}{12} - \frac{x^3}{24} + \dots$ D. $1 - \frac{x}{2} + \frac{x^2}{12} - \frac{x^3}{24} + \dots$
 E. $1 + \frac{x^3}{12} + \frac{x^3}{24} - \frac{x^4}{63} + \dots$
5. $(4\sqrt{3} + 4\sqrt{2})(4\sqrt{3} - 4\sqrt{2})(3\sqrt{3} + \sqrt{2})$ is equal to
 A. 0 B. $4\sqrt{3} + 4\sqrt{2}$
 C. $(4\sqrt{2} - 4\sqrt{3})(\sqrt{3} + \sqrt{2})$
 D. $\sqrt{3} + \sqrt{2}$ E. 1
16. In a restaurant, the cost of providing a particular type of food is partly constant and partly inversely proportional to the number of people. If the cost per head for 100 people is 30k and the cost for 40 people is 60k, find the cost for 50 people
 A. 15k B. 45k C. 20k
 D. 50k E. 40k
17. The factors of $9 - (x^2 - 3x - 1)^2$ are
 A. $-(x - 4)(x + 1)(x - 1)(x - 2)$
 B. $(x - 4)(x - 1)(x - 1)(x + 2)$
 C. $-(x - 2)(x + 1)(x + 2)(x + 4)$
 D. $(x - 4)(x - 3)(x - 2)(x + 1)$
 E. $(x - 2)(x + 2)(x - 1)(x + 1)$
18. If $3^{2y} - 6(3^y) = 27$ find y
 A. 3 B. -1 C. 2
 D. -3 E. 1
19. Factorize $abx^2 + 8y - 4bx - 2axy$
 A. $(ax - 4)(bx - 2y)$ B. $(ax + b)(x - 8y)$
 C. $(ax - 2y)(by - 4)$ D. $(abx - 4)(x - 2y)$
 E. $(bx - 4)(ax - 2y)$
20. At what real value of x do the curves whose equations are $y = x^3 + x$ and $y = x^2 + 1$ intersect?
 A. -2 B. 2 C. -1
 D. 0 E. 1
21. If the quadrilateral function $3x^2 - 7x + R$ is a perfect square find R
 A. $49/24$ B. $49/3$ C. $49/6$
 D. $49/12$ E. $49/36$
22. Solve the following equation $2/(2r - 1) - 5/3 = 1/(r + 2)$
 A. $(-1, 5/2)$ B. $(-1, -5/2)$
 C. $(5/2, 1)$ D. $(2, 1)$
 E. $(1, 2)$
23. Solve for (x, y) in the equations $2x + y = 4; x^2 + xy = -12$
 A. $(6, -8); (-2, 8)$ B. $(3, -4); (-1, 4)$
 C. $(8, -4); (-1, 4)$ D. $(-8, 6); (8, -2)$
 E. $(-4, 3); (4, -1)$
24. Solve the simultaneous equations $2x - 3y + 10 = 10x - 6y = 5$
 A. $x = 2^{1/2}, y = 3^{1/2}$ B. $x = 3^{1/2}, y = 2^{1/2}$
 C. $x = 2^{1/2}, y = 3^3$ D. $x = 3^{1/2}, y = 2^{1/2}$
 E. $x = 2^{1/2}, y = 2^{1/2}$
25. If $f(x - 2) = 4x^2 + x + 7$ find $f(1)$
 A. 12 B. 27 C. 7
 D. 46 E. 17
26. In DXYZ, $XY = 13\text{cm}, YZ = 9\text{cm}, XZ = 11\text{cm}$ and $\angle XYZ = 90^\circ$. find $\cos \angle X$
 A. $4/39$
 B. $43/39$
 C. $209/286$
 D. $1/6$
 E. $43/78$
27. Find the missing value in the table below
- | | | | | | | |
|-------------------|----|----|---|---|---|----|
| x | -2 | -1 | 0 | 1 | 2 | 3 |
| $y = x^2 - x + 3$ | | 3 | 3 | 3 | 9 | 27 |
- A. -32 B. -14 C. 40
 D. 22 E. 37
28. Find the number of goals scored by a football team in 20 matches is shown below
- | | | | | | | |
|----------------|---|---|---|---|---|---|
| No. of goals | 0 | 1 | 2 | 3 | 4 | 5 |
| No. of matches | 3 | 5 | 7 | 4 | 1 | 0 |
- What are the values of the mean and the mode respectively?
 A. (1.75, 5) B. (1.75, 2)
 C. (1.75, 1) D. (2, 2)
 E. (2, 1)
29. If the hypotenuse of a right angle isosceles triangle is 2, what is the length of each of the other sides?
 A. $\sqrt{2}$ B. $1/\sqrt{2}$ C. $2\sqrt{2}$
 D. 1 E. $\sqrt{2} - 1$
30. If two fair coins are tossed, what is the probability of getting at least one head?
 A. $1/4$ B. $1/2$ C. 1
 D. $2/3$ E. $3/4$
31. The ratio of the length of two similar rectangular blocks is 2:3, if the volume of the larger block is 351cm^3 , then the volume of the other block is
 A. 234.00cm^3 B. 526.50cm^3
 C. 166.00cm^3 D. 729.75cm^3
 E. 104.00cm^3
32. The bearing of bird on a tree from a hunter on the ground is $N72^\circ E$. what is the bearing of the hunter from the bird?
 A. $S18^\circ W$ B. $S72^\circ W$
 C. $S72^\circ E$ D. $S27^\circ E$
 E. $S27^\circ W$

33.X

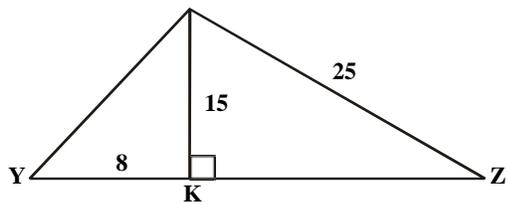

In ΔXYZ above, $\angle XKZ = 90^\circ$, $XK = 15\text{cm}$, $XZ = 25\text{cm}$ and $YK = 8\text{cm}$. Find the area of ΔXYZ .

- A. 180sq.cm B. 210sq.cm
C. 160sq.cm D. 320sq.cm
E. 390sq.cm

34. Without using tables. Calculate the value of $1 + \sec^2 30^\circ$?

- A. $2\frac{1}{3}$ B. 2 C. $1\frac{1}{3}$
D. $\frac{3}{4}$ E. $\frac{3}{7}$

35. What is the probability that a number chosen at random from the integers between 1 and 10 inclusive is either a prime or a multiple of 3?

- A. $\frac{7}{10}$ B. $\frac{3}{5}$ C. $\frac{4}{5}$
D. $\frac{1}{2}$ E. $\frac{3}{10}$

36. Find the area of a regular hexagon inscribed in a circle of radius 8cm.

- A. $16\sqrt{3}\text{cm}^2$ B. $96\sqrt{3}\text{cm}^2$
C. 192.3cm^2 D. 16cm^2
E. 32cm^2

37.X

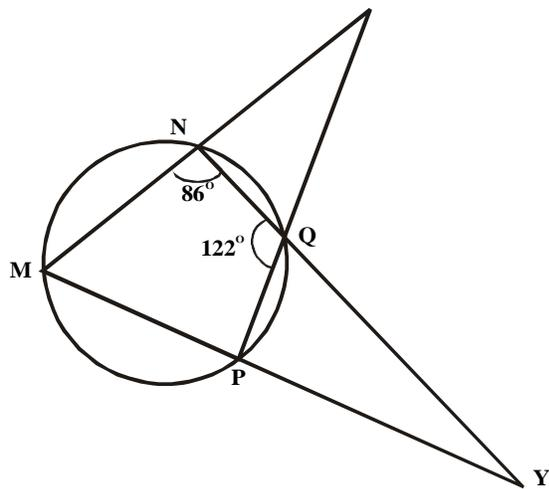

In the figure above, MNOP is a cyclic quadrilateral, MN and PQ are produced to meet at X and NQ and MP are produced to meet at Y. if $\angle MNQ = 86^\circ$ and $\angle NQP = 122^\circ$, find (x°, y°)

- A. $(28^\circ, 36^\circ)$ B. $(36^\circ, 28^\circ)$
C. $(43^\circ, 61^\circ)$ D. $(61^\circ, 43^\circ)$
E. $(36^\circ, 43^\circ)$

38. If $\cos q = \frac{\sqrt{3}}{2}$ and 0 is less than 90° , calculate $\cot(90^\circ - q) / \sin^2 q$

- A. $4\sqrt{3}/3$ B. $4\sqrt{3}$
C. $\sqrt{3}/2$ D. $1/\sqrt{3}$
E. $2/\sqrt{3}$

39. A solid sphere of radius 4cm has mass of 64kg. What will be the mass of a shell of the same metal whose internal and external radii are 2cm and 3cm respectively?

- A. 5kg B. 16kg C. 19kg
D. 25kg E. 48kg

40.

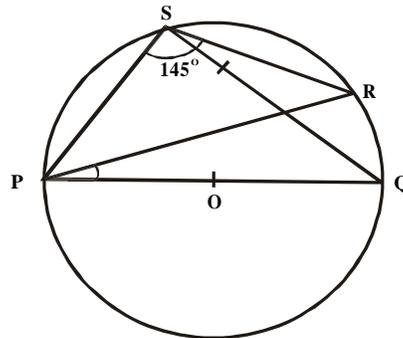

In the figure above POQ is the diameter of the circle PQRS. If $\angle PSR = 145^\circ$, find x°

- A. 25° B. 35° C. 45°
D. 55° E. 25°

41.

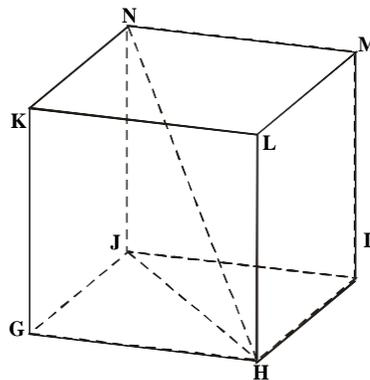

In the figure above GHIJKLMN is a cube of side a. find the length of HN

- A. $3\sqrt{a}$ B. $3a$ C. $3a^2$
D. $a\sqrt{2}$ E. $a\sqrt{3}$

42. PQRS is a trapezium of area 14cm^2 in which $PQ \parallel RS$, if $PQ = 4\text{cm}$ and $SR = 3\text{cm}$, find the area of ΔSQR in cm^2

- A. 7.0 B. 6.0 C. 5.2
D. 5.0 E. 4.1

43.

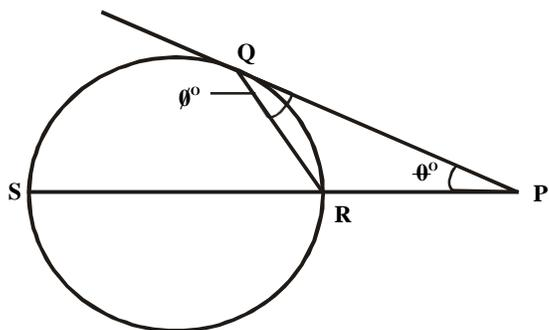

In the figure PQ is the tangent from P to the circle QRS with SR as its diameter. If $\angle PQR = q^\circ$, which of the following relationship θ° is correct?

- A. $q^\circ + \theta^\circ = 90^\circ$ B. $\theta^\circ = 90^\circ - 2q^\circ$
C. $q^\circ = \theta^\circ$ D. $\theta^\circ = 2q^\circ$
E. $q^\circ + 2\theta^\circ = 120^\circ$

44. A bag contains 4 white balls and 6 red balls. Two Redballs are taken from the bag without replacement. What is the probability that they are both red?
 A. $1/3$ B. $2/9$ C. $2/15$
 D. $1/5$ E. $3/5$
45. How many $2\sqrt{2}$ cm diameter discs can be cut out of a sheet of cardboard $2\sqrt{2}p^{3/4}$ cm long and $\sqrt{p^{1/2}}$ cm wide?
 A. 4^9 B. 2^{19} C. $2^{17}p^{3/4}(\sqrt{2p+2})$
 D. $2^{10}p^{3/4}(1+\sqrt{2})$ E. $2^9(\sqrt{2}+1)$

46. Two points X and Y both on latitude 60° S have longitudes 147° E and 153° W respectively. Find to the nearest kilometre the distance between X and Y measured along the parallel of latitudes (Take $2\pi R = 4 \times 10^4$ km, where R is the radius of the earth).
 A. 28.850km B. 16.667km
 C. 8.333km D. 6.667km
 E. 3.333km

47.

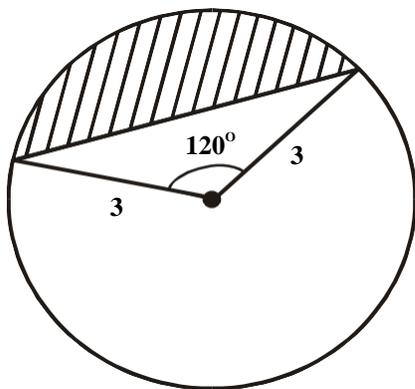

- In the figure above the area of the shaded segment is
 A. $3p$ B. $9\sqrt{3}/4$
 C. $3(p - 3\sqrt{3}/4)$ D. $3(\sqrt{3} - p)/4$
 E. $p + 9\sqrt{3}/4$

48. In a class of 120students, 18 of them scored an A grade in Mathematics. If the section representing the A grade students on a pie chart has angle Z° at the centre of the circle, what is Z ?
 A. 15 B. 28 C. 50
 D. 52 E. 54

49.

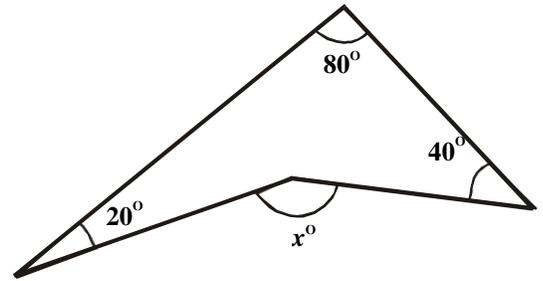

- In the figure above find the angle x
 A. 100° B. 120° C. 60°
 D. 110° E. 140°

50. If $a \frac{(x+1)}{(x-2)} - \frac{(x+1)}{(n+2)} = bx$

- Find a simplest form
 A. $x^2 - 1$ B. $x^2 + 1$ C. $x^2 + 4$
 D. 1 E. $x^2 - 4$

Mathematics 1986

1. Evaluate $(212)_3 - (121)_3 + (222)_3$
 A. $(313)_3$ B. $(1000)_3$
 C. $(1020)_3$ D. $(1222)_3$
2. If Musa scored 75 in Biology instead of 57, his average mark in four subjects would have been 60. what was his total mark?
 A. 282 B. 240
 C. 222 D. 210
3. Divide the L.C.M. of 48, 64 and 80 by their H.C.F
 A. 20 B. 30
 C. 48 D. 60
4. Find the smallest number by which 252 can be multiplied to obtain a perfect square
 A. 2 B. 3
 C. 5 D. 7
5. Find the reciprocal of $\frac{2/3}{1/2 + 1/3}$
 A. $4/5$ B. $5/4$
 C. $2/5$ D. $6/7$
6. Three boys shared some oranges. The first receive $1/3$ of the oranges, the second received $2/3$ of the remainder, if the third boy received the remaining 12 oranges. How many oranges did they share?
 A. 60 B. 54
 C. 48 D. 42
7. If $P = 18, Q = 21, R = -6$ and $S = -4$ calculate $(P - Q) + S^2$
 A. $-11/216$ B. $11/216$
 C. $-43/115$ D. $41/116$

8. Simplify $\frac{0.03 \times 4 \times 0.00064}{0.48 \times 0.012}$
 A. 3.6×10^2 B. 36×10^2
 C. 3.6×10^3 D. 3.6×10^4
9. Udoh deposited #150 00 in the bank. At the end of 5 years the simple interest on the principal was #55 00. At what rate per annum was the interest paid?
 A. 11% B. $7\frac{1}{3}\%$
 C. 5% D. $3\frac{1}{2}\%$
10. A number of pencils were shared out among Bisi, Sola and Tunde in the ratio 2:3:5 respectively. If Bisi got 5, how many were shared out?
 A. 15 B. 25
 C. 30 D. 50
11. The ages of Tosan and Isa differ by 6 and the product of their ages is 187. write their ages in the form (x, y), where $x > y$
 A. (12, 9) B. (23, 17)
 C. (17, 11) D. (18, 12)
12. In 1984, Ike was 24 years old and his father was 45 years old in what year was Ike exactly half his father's age?
 A. 1982 B. 1981
 C. 1979 D. 1978
13. Simplify $\left(\frac{1}{\sqrt{5} + \sqrt{3}} - \frac{1}{\sqrt{5} - \sqrt{3}}\right) \times -1/\sqrt{3}$
 A. $\sqrt{3}/\sqrt{5}$ B. $-2/\sqrt{3}$
 C. -2 D. -1
14. Find n if $\text{Log } 4 + \text{Log } Z - \text{Log } n = -1$
 A. 10^{-2} B. 10^2
 C. 27 D. 28
15. $(91/3 \times 27 - 1/2) / (3^{-1/6} \times 3^{-2/3})$
 A. 1/3 B. 1
 C. 3 D. 9
16. If x varies directly as y^3 and $x = 2$ when $y = 1$, find x when $y = 5$
 A. 2 B. 10
 C. 125 D. 250
17. Factorize completely.
 $3a + 125ax^3$
 A. $(2a + 5x^2)(4 + 25ax)$
 B. $a(2 + 5x)(4 - 10x + 25ax^2)$
 C. $(2a + 5x)(4 - 10ax + 25ax^2)$
 D. $a(2 + 5x)(4 + 10ax + 25ax^2)$
18. If $y = x/(x-3) + x/(x+4)$ find y when $x = -2$
 A. -3/5 B. 3/5
 C. -7/5 D. 7/5
19. Find all the numbers x which satisfy the inequality $1/3(x+1) - 1 > 1/5(x+4)$
 A. $x < 11$ B. $x < -1$
 C. $x > 6$ D. $x > 11$
20. Factorize $x^2 + 2a + ax + 2x$
 A. $(x+2a)(x+1)$ B. $(x+2a)(x-1)$
 C. $(x^2-1)(x+a)$ D. $(x+2)(x+a)$
21. Solve the equation $3x^2 + 6x - 2 = 0$
 A. $x = -1, \pm\sqrt{3}/3$ B. $x = -1, \pm\sqrt{15}/\sqrt{3}$
 C. $x = -2, \pm\sqrt{3}/3$ D. $x = -2, \pm\sqrt{15}/3$
22. Simplify. $1/5x + 5 + 1/7x + 7$
 A. $12/35 + 7$ B. $1/35(x+1)$
 C. $12x/35(x+1)$ D. $12/35x + 35$
23. The curve $y = -x^2 + 3x + 4$ intersects the coordinate axes at
 A. (4,0)(0,0)(-1,0) B. (-4,0)(0,4)(1,1)
 C. (0,0)(0,1)(1,0) D. (0,4)(4,0)(-1,0)
24. Factorize $(4a + 3)^2 - (3a - 2)^2$
 A. $(a+1)(a+5)$ B. $(a-5)(7a-1)$
 C. $(a+5)(7a+1)$ D. $a(7a+1)$
25. If $5^{(x+2y)} = 5$ and $4^{(x+3y)} = 16$, find $3^{(x+y)}$
 A. 0 B. 1
 C. 3 D. 27
26. Simplify $1/x - 2 + 1/x + 2 + 2x/x^2 - 4$
 A. $2x/(x-2)(x+2)(x^2-4)$ B. $2x/x^2 - 4$
 C. $x/x^2 - 4$ D. $4x/x^2 - 4$
27. Make r the subject of the formula
 $S = 6/v - w/2$
 A. $V = \frac{6}{S^2} = \frac{12}{w}$ B. $v = \frac{12}{25^2 - w}$
 C. $v = \frac{12}{w} - 2s^2$ D. $v = \frac{12}{2s^2 + w}$
28. Find the values of x which satisfy the equation
 $16^x - 5x \cdot 4^x + 4 = 0$
 A. 1 and 4 B. -2 and 2
 C. 0 and 1 D. 1 and 0
29. $a/b - c/d = k$, find the value of $(3a^2 - ac + c^2)/(3b^2 - bd + d^2)$ in term of k
 A. $3k^2$ B. $3k - k^2$
 C. $17k^2/4$ D. k^2
30. At what point does the straight line $y = 2x + 1$ intersect the curve $y = 2x^2 + 5x - 1$?
 A. (-2, -3) and (1/2, 2) B. (-1/2, 0) and (2, 5)
 C. (1/2, 2) and (1, 3) D. (1, 3) and (2, 5)
31. A regular polygon on n sides has 160° as the size each interior. Find n.
 A. 18 B. 16
 C. 14 D. 12
32. If $\cos q = a/b$, find $1 + \tan^2 q$
 A. b^2/a^2 B. a^2/b^2
 C. $(a^2 + b^2)/(b^2 - a^2)$ D. $(2a^2 + b^2)/(a^2 + b^2)$

33. In the diagram below, PQ and RS are chords of a circle centre O which meet at T outside the circle. If TP = 24cm, TQ = 8cm and TS = 12cm, find TR.

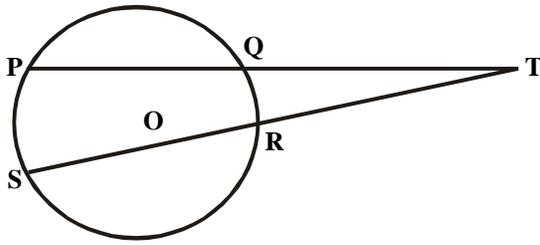

- A. 16cm B. 14cm
C. 12cm D. 8cm

34. The angle of elevation of the top of a vertical tower 50 metres high from a point X on the ground is 30° . From a point Y on the opposite side of the tower, the angle of elevation of the top of the tower is 60° . find the distance between the points X and Y.

- A. 14.43m B. 57.73m
C. 101.03m D. 115.47m

35. A girl walk 45 metres in the direction 050° from a point Q to a point X. She then walks 24metres in the direction 140° from X to a point Y. How far is she then from Q?

- A. 69m B. 57m
C. 51m D. 21m

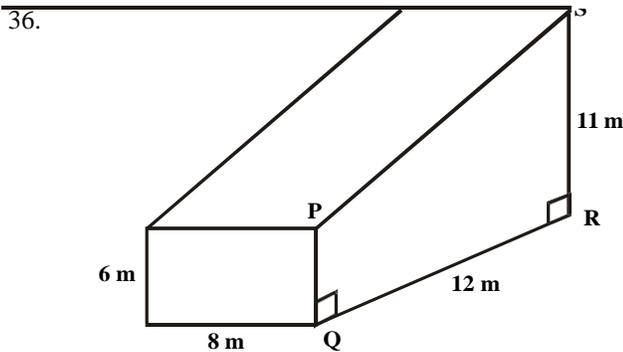

The figure is a solid with the trapezium PQRS as its uniform cross-section. Find its volume

- A. 102m^3 B. 576m^3
C. 816m^3 D. 1056m^3

- 37.

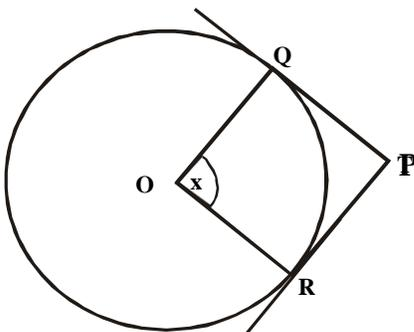

PQ and PR are tangents from P to a circle centre O as shown in the figure above. If $\text{QRP} = 34^\circ$. Find the angle marked x.

- A. 34° B. 56°
C. 68° D. 112°

38. An arc of circle of radius 6cm is 8cm long. Find the area of the sector.

- A. $5\frac{1}{3}\text{cm}^2$ B. 24cm^2
C. 36cm^2 D. 48cm^2

- 39.X

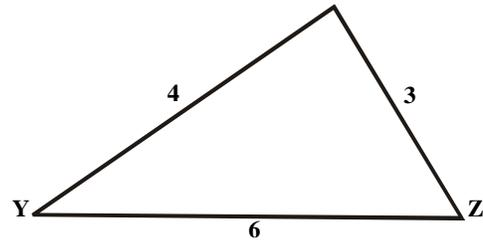

In $\triangle XYZ$ above, determine the cosine of angle Z

- A. $\frac{3}{4}$ B. $\frac{29}{36}$
C. $\frac{2}{3}$ D. $\frac{1}{2}$

- 40.

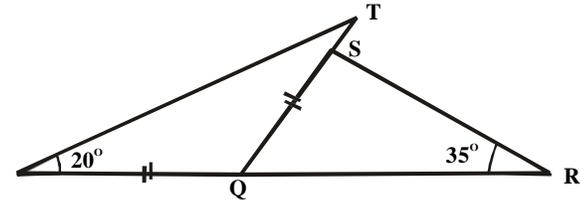

In the figure above $\triangle PQT$ is isosceles. $PQ = QT$. $\text{SRQ} = 35^\circ$, $\text{TQ} = 20^\circ$ and PQR is a straight line. Calculate TSR.

- A. 20° B. 55°
C. 75 D. 140°

41. Find the total surface are of a solid cone of radius $2\sqrt{3}\text{cm}$ and slanting side $4\sqrt{3}\text{cm}$

- A. $8\sqrt{3}\text{cm}^2$ B. 24cm^2
C. $15\sqrt{3}\text{cm}^2$ D. 36cm^2

42. If U and V are two distinct fixed points and W is a variable point such that UWV is a straight angle. What is the locus of W?

- A. The perpendicular bisector of UV
B. A circle with UV as radius
C. A line parallel to the line UV
D. A circle with the line UV as the diameter

- 43.

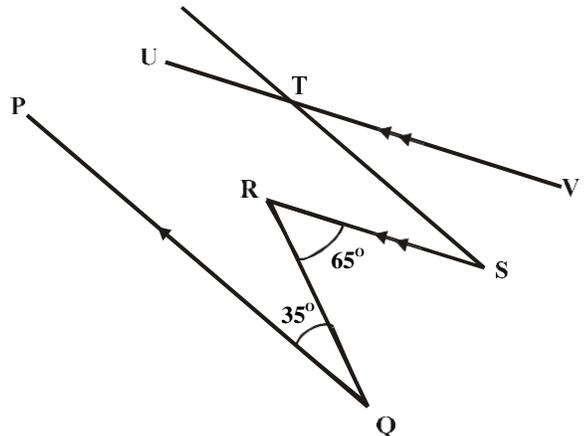

In the figure above, $PQ \parallel ST$, $RS \parallel UV$. If $\text{PQR} = 35^\circ$ and $\text{QRS} = 65^\circ$, find STV

- A. 30° B. 35°
C. 55° D. 65°

44. An open rectangular box externally measures 4m x 3m x 4m. find the total cost of painting the box externally if it costs #2.00 to paint onesquare metre.

- A. #96.00 B. #112.00
C. #136.00 D. #160.00

45. Of the nine hundred students admitted in a university in 1979, the following was the distribution by state

Anambra	185
Imo	135
Kaduna	90
Kwara	110
Ondo	155
Oyo	225

In a pie chart drawn to represent this distribution, the angle subtended at the centre by Anambra is

- A. 50° B. 65°
C. 74° D. 88°

46. Find the median of the numbers 89, 141, 130, 161, 120, 131, 131, 100, 108 and 119

- A. 131 B. 125
C. 123 D. 120

47. Find the probability that a number selected at random from 40 to 50 is a prime

- A. 3/11 B. 5/11
C. 3/10 D. 4/11

48. The people in a city with a population of 109 million were grouped according to their ages. Use the diagram below to determine the number of people in the 15-29 years group.

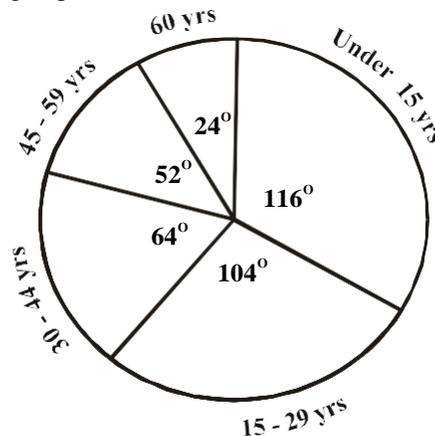

- A. 29×10^4 B. 26×10^4
C. 16×10^4 D. 13×10^4

49. A man kept 6black, 5 brown and 7 purple shirts in a drawer. What is the probability of his picking a purple shirt with his eyes closed?

- A. 1/7 B. 11/18
C. 7/18 D. 7/11

50. The table below gives the scores of a group of students in a Mathematics test

Score	1	2	3	4	5	6	7	8
Frequency	2	4	7	14	12	6	4	1

If the mode is m and the number of students who scored 4 or less is S. What is (s, m)?

- A. (27,4) B. (14,4)
C. (13,4) D. (4,4)

Mathematics 1987

1. Convert 241 in base 5 to base 8

- A. 71_8 B. 107_8
C. 176_8 D. 241_8

2. Find the least length of a rod which can be cut into exactly equal strips, each of either 40cm or 48cm in length.

- A. 120cm B. 240cm
C. 360cm D. 480cm

3. A rectangular lawn has an area of 1815square yards. If its length is 50meters, find its width in metres. Given that 1meters equals 1.1yards

- A. 39.93 B. 35.00
C. 33.00 D. 30.00

4. Reduce each number to two significant figures and then evaluate (0.02174×1.2047)

0.023789

- A. 0.8 B. 0.9
C. 1.1 D. 1.2

5. A train moves from P to Q at an average speed of 90km/hr and immediately returns from Q to P through the same route and at an average speed of 45km/h. find the average speed for the entire journey.

- A. 55.00km/hr B. 60.00km/hr
C. 67.50km/hr D. 75.00km/hr

6. If the length of a square is increased by 20% while its width is decreased by 20% to form a rectangle, what is the ratio of the area of the rectangle to the area of the square?

- A. 6.5 B. 25.24
C. 5.6 D. 24.25

7. Two brothers invested a total of #5,000.00 on a farm project. The farm yield was sold for # 15, 000.00 at the end of the season. If the profit was shared in the ratio 2:3, what is the difference in the amount of profit received by the brothers?
 A. #2,000.00 B. #4,000.00
 C. #6,000.00 D. #10,000.00
8. Peter's weekly wages are #20.00 for the first 20 weeks and #36.00 for the next 24 weeks. Find his average weekly wage for the remaining 8 weeks of the year. If his average weekly wage for the whole year is #30.00
 A. #37.00 B. #35.00
 C. #30.00 D. #5.00
9. A man invests a sum of money at 4% per annum simple interest. After 3 years, the principal amounts to #7,000.00. find the sum invested
 A. #7,840.00 B. #6,250.00
 C. #6,160.00 D. #5,833.33
10. By selling 20 oranges for #1.35 a trader makes a profit 8%. What is his percentage gain or loss if he sells the same 20 oranges for #1.10?
 A. 8% B. 10%
 C. 12% D. 15%
11. Four boys and ten girls can cut a field in 5 hours. If the boys work at 1/4 the rate of which the girls work, how many boys will be needed to cut the field in 3 hours?
 A. 180 B. 60
 C. 25 D. 20
12. Evaluate without using tables.
 A. 625/8 B. 8/625
 C. 1/8 D. 8
13. Instead of writing 35/6 as a decimal correct to 3 significant figures, a student wrote it correct to 3 places of decimals. Find his error in standard form
 A. 0.003 B. 3.0×10^{-3}
 C. 0.3×10^2 D. 0.3×10^{-3}
14. Simplify without using tables
 $(\text{Log}_2 6 - \text{Log}_2 3) / (\text{Log}_2 8 - 2\text{Log}_2 1/2)$
 A. 1/5 B. 1/2
 C. -1/2 D. $\text{Log}_2 3 / \text{Log}_2 7$
15. Simplify without using tables
 $2\sqrt{14 \times 3\sqrt{21}} / 7\sqrt{24 \times 2\sqrt{98}}$
 A. $\frac{3\sqrt{14}}{4}$ B. $\frac{3\sqrt{21}}{4}$
 C. $\frac{3\sqrt{14}}{28}$ D. $\frac{3\sqrt{2}}{28}$
16. If $p = \frac{2}{3}(1 - r^2)/n^2$, find n when $r = \frac{1}{3}$ and $p = 1$
 A. 3/2 B. 3
 C. 1/3 D. 2/3
17. If $a = U^2 - 3V^2$ and $b = 2UV + V^2$ evaluate $(2a - b)(a - b^3)$ when $u = 1$ and $v = -1$
 A. 9 B. 15
 C. 27 D. 33

18. The formula $Q = 15 + 0.5n$ gives the cost Q (in Naira) of feeding n people for a week. Find in kobo the extra cost of feeding one additional person.
 A. 350k B. 200k
 C. 150k D. 50k
19. If P varies inversely as V and V varies directly as R^2 , find the relationship between P and R given that $R = 7$ when $P = 2$
 A. $P = 98R^2$ B. $PR^2 = 98$
 C. $P = 1/98R$ D. $P = R^2/98$
20. Make y the subject of the formula
 $Z = x^2 + 1/y^3$
 A. $y = \frac{1}{(z - x^2)^3}$ B. $y = \frac{1}{(z + x^3)^{1/3}}$
 C. $y = \frac{1}{(z - x^2)^{1/3}}$ D. $y = \frac{1}{\sqrt[3]{z - \sqrt[3]{x^2}}}$
21. Find the values of m which make the following quadratic function a perfect square
 $x^2 + 2(m + 1)x + m + 3$
 A. -1, 1 B. -1, 2
 C. 1, -2 D. 2, -2
22. Factorize $6^{2x+1} + 7(6x) - 5$
 A. $\{3(6^x) - 5\} \{2(6^x) + 1\}$
 B. $\{3(6^x) - 5\} \{2(6^x) - 1\}$
 C. $\{2(6^x) - 5\} \{3(6^x) + 1\}$
 D. $\{2(6^x) - 5\} \{3(6^x) - 1\}$
23. Find two values of y which satisfy the simultaneous equations $x + y = 5$, $x^2 - 2y^2 = 1$
 A. 12, -2 B. -12, 12
 C. -12, 2 D. 2, -2
24. An $(n - 2)^2$ sided figure has n diagonals find the number n of diagonals for a 25 sided figure
 A. 7 B. 8
 C. 9 D. 10
- 25.

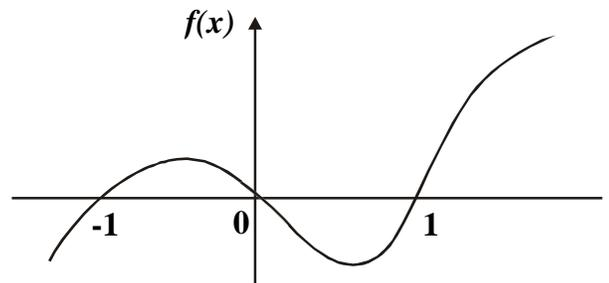

A cubic function $f(x)$ is specified by the graph show above. The values of the independent variable for which the function vanishes are

- A. -1, 0, 1 B. $-1 < x < 1$
 C. $x, -1$ D. $x > 1$
26. Solve the inequality $x - 1 > 4(x + 2)$
 A. $x > -3$ B. $x < -3$
 C. $2 < x < 3$ D. $-3 < x < -2$

27. Simplify $(x^2 - y^2) / (2x^2 + xy - y^2)$
 A. $\frac{x + y}{2x + y}$ B. $\frac{x + y}{2x - y}$
 C. $\frac{x - y}{2x - y}$ D. $\frac{x - y}{2x + y}$

28. The minimum value of y in the equation $y = x^2 - 6x + 8$ is
 A. 8 B. 3
 C. 0 D. -1

29. Find the sum of the first 21 terms of the progression -10, -8, -6, ...
 A. 180 B. 190
 C. 200 D. 210

30. Find the eleventh term of the progression 4, 8, 16, ...
 A. 2^{13} B. 2^{12}
 C. 2^{11} D. 2^{10}

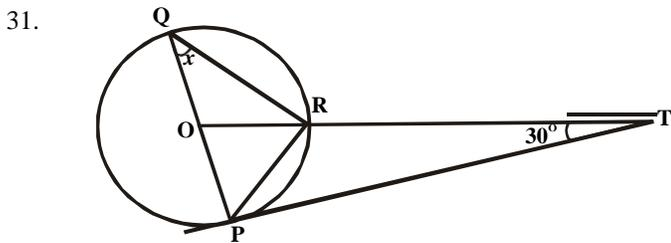

- In the diagram above, POQ is a diameter, O is the centre of the circle and TP is a tangent. Find the value of x .
 A. 45° B. 40°
 C. 45° D. 50°

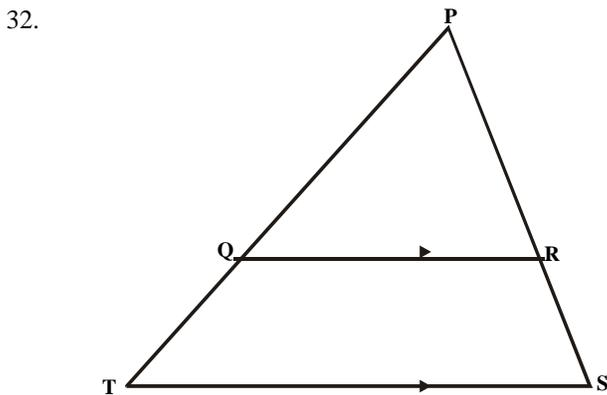

- In the diagram above, $QR // TS$, $QR:TS = 2:3$. find the ratio of the area of triangle PQR to the area of the trapezium QRST
 A. 4:9 B. 4:5
 C. 1:3 D. 2:3

33. Three angles of a nonagon are equal and the sum of six other angles is 1110° . Calculate the size of one of the equal angles
 A. 210° B. 150°
 C. 105° D. 50°

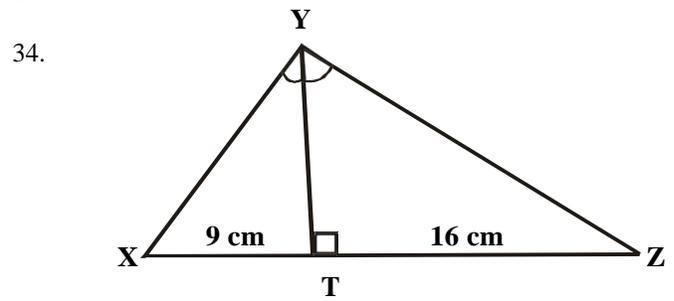

- In the figure above, $\angle XYZ = \angle YTZ = 90^\circ$, $XT = 9\text{cm}$ and $TZ = 16\text{cm}$. Find YZ
 A. 25cm B. 20cm
 C. 16cm D. 9cm

35. Two chords QR and NP of a circle intersect inside the circle at X. if $\angle RQP = 37^\circ$, $\angle RQN = 49^\circ$ and $\angle QPN = 35^\circ$, find $\angle PRQ$
 A. 35° B. 37°
 C. 49° D. 59°

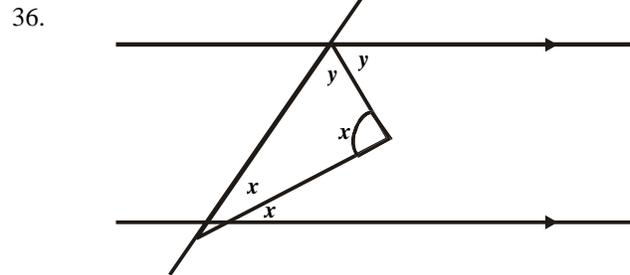

- In the figure above, find the value of x .
 A. 110° B. 100°
 C. 90° D. 80°

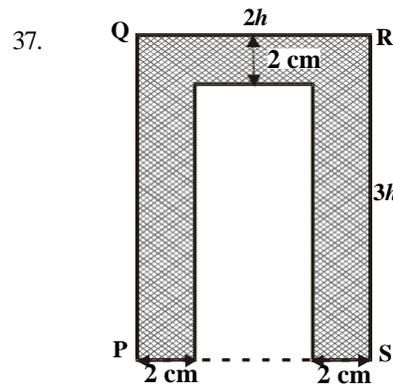

- In the figure above, PQRS is a rectangle. If the shaded area is 72sq.cm find h
 A. 12cm B. 10cm
 C. 8cm D. 5cm

38. The sine, cosine and tangent of 210° are respectively
 A. $-1/2, \sqrt{3}/2, \sqrt{3}/3$ B. $1/2, \sqrt{3}/2, \sqrt{3}/3$
 C. $\sqrt{3}/2, \sqrt{3}, 1$ D. $3/2, \sqrt{2}, 1$

39. If $\tan q = (m^2 - n^2) / 2mn$, find $\sec q$
 A. $(m^2 + n^2) / (m^2 - n^2)$ B. $(m^2 + n^2) / 2mn$
 C. $mn / 2(m^2 - n^2)$ D. $m^2 n^2 / (m^2 - n^2)$

40. From two points X and Y, 8m apart, and in line with a pole, the angle of elevation of the top of the pole are 30° and 60° respectively. Find the height of the pole, assuming that X, Y and the foot of the pole are on the same horizontal plane.

- A. 4m
 B. $8\sqrt{3}/2$ m
 C. $4\sqrt{3}$ m
 D. $8\sqrt{3}$ m

41. A room is 12m long, 9m wide and 8m high. Find the cosine of the angle which a diagonal of the room makes with the floor of the room

- A. $15/17$
 B. $8/17$
 C. $8/15$
 D. $12/17$

42. What is the circumference of radius of the earth?

- A. $R \cos q$
 B. $2p R \cos q$
 C. $R \sin q$
 D. $2p R \sin q$

43. The base of a pyramid is a square of side 8cm. If its vertex is directly above the centre, find the height, given that the edge is 4.3cm

- A. 6cm
 B. 5cm
 C. 4cm
 D. 3cm

44.

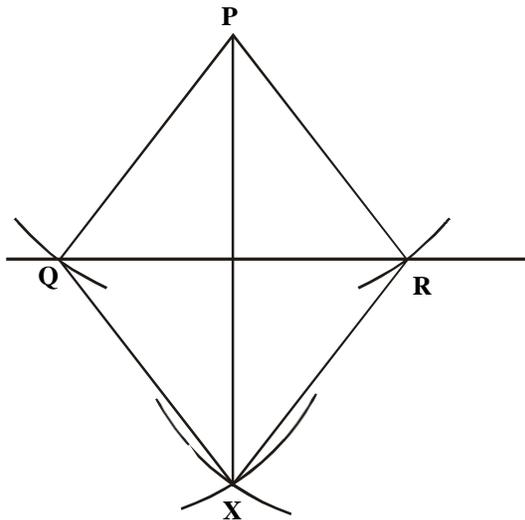

The figure above is an example of the construction of a

- A. perpendicular bisector to a given straight line
 B. perpendicular from a given point to a given line
 C. perpendicular to a line from a given point on that line
 D. given angle.

45. What is the locus of the mid-points of all chords of length 6cm within a circle of radius 5cm and with centre O.

- A. A circle of radius 4cm and with centre O
 B. The perpendicular bisector of the chords
 C. A straight line passing through center O
 D. A circle of radius 6cm and with centre O

46. Taking the period of daylight on a certain day to be from 5.30a.m to 7.00p.m, calculate the period of daylight and of darkness on that day

- A. $187^\circ 30'$ $172^\circ 30'$
 B. $135^\circ 225'$
 C. $202^\circ 30'$ $157^\circ 30'$
 D. $195^\circ 165'$

47. The goals scored by 40 football teams from three league divisions are recorded below

Number of goals	0	1	2	3	4	5	6
Frequency	4	3	15	16	1	0	1

What is the total number of goals scored by all the teams?

- A. 21
 B. 40
 C. 91
 D. 96

48. The numbers 3,2,8,5,7,12,9 and 14 are the marks scored by a group of students in a class test if P is the mean and Q the median the $P + Q$ is

- A. 18
 B. $17\frac{1}{2}$
 C. 16
 D. 15

49. Below are the scores of a group of students in a music test

Scores	1	2	3	4	5	6	7	8	9
No. of students	3	6	10	8	6	5	2	4	12

If $CF(x)$ is the number of students with scores less than or equal to x, find $CF(6)$

- A. 40
 B. 38
 C. 33
 D. 5

50. Find the probability of selecting a figure which is parallelogram from a square, a rectangle, a rhombus, a kite and a trapezium

- A. $3/5$
 B. $2/5$
 C. $4/5$
 D. $1/5$

Mathematics 1988

1. Simplify $(1\frac{1}{2} \div \frac{1}{4})$ of 32

- A. $3/256$
 B. $3/32$
 C. 6
 D. 85

2. If x is the addition of the prime numbers between 1 and 6, and y the H.C.F of 6,9, 15, find the product of x and y

- A. 27
 B. 30
 C. 33
 D. 90

3. A 5.0g of salts was weighed by Tunde as 5.1g. what is the percentage error?

- A. 20
 B. 2
 C. 2
 D. 0.2

4. Find correct to one decimal place, $0.24633/0.0306$

- A. 0.8
 B. 1.8
 C. 8.0
 D. 8.1

5. Two sisters, Taiwo and Kehinde, own a store. The ratio of Taiwo's share to Kehinde's is 11:9. Later Kehinde sells $\frac{2}{3}$ of her share to Taiwo for #720.00. Find the value of the store.
 A. #1,080.00 B. #2,400.00
 C. #3,000.00 D. #3,600.00
6. A basket contains green, black and blue balls in the ratio 5:2:1. If there are 10 blue balls, find the corresponding new ratio when 10 green and 10 black balls are removed from the basket.
 A. 1:1:1 B. 4:2:1
 C. 5:1:1 D. 4:1:1
7. A taxpayer is allowed $\frac{1}{8}$ th of his income tax free, and pays 20% on the remainder. If he pays #490.00 tax, what is his income?
 A. #560.00 B. #2,450.00
 C. #2,800.00 D. #3,920.00
8. Evaluate $(8^{1/3} \times 5^{2/3}) / 10^{2/3}$
 A. $\frac{2}{5}$ B. $\frac{5}{3}$
 C. $2\sqrt{5}$ D. $3\sqrt{5}$
9. If $\log_{10} 2 = 0.3010$ and $\log_{10} 3 = 0.4771$, evaluate, without using logarithm tables $\log_{10} 4.5$
 A. 0.3010 B. 0.4771
 C. 0.6352 D. 0.9542
10. Find m such that $(m, 3) (1 - \sqrt{3})^2 = 6 - \sqrt{3} = 6 - 2\sqrt{3}$
 A. 1 B. 2
 C. 3 D. 4
11. The thickness of an 800-paged book is 18mm. Calculate the thickness of one leaf of the book giving your answer in metres and in standard form.
 A. $2.25 \times 10^{-4}m$ B. $4.50 \times 10^{-4}m$
 C. $2.25 \times 10^{-5}m$ D. $4.50 \times 10^{-5}m$
12. Simplify $\frac{(x+2) - (x-2)}{(x+1)(x+2)}$
 A. $\frac{3}{x+1}$ B. $\frac{3x+2}{(x+1)(x+2)}$
 C. $\frac{5x+6}{(x+1)(x+2)}$ D. $\frac{2x^2+5x+2}{(x+1)(x+2)}$
13. If $\frac{1}{p} = \frac{a^2+2ab+b^2}{(a-b)}$ and $\frac{1}{q} = \frac{(a+b)}{(a^2-2ab+b^2)}$ find $\frac{p}{q}$
 A. $\frac{a+b}{a-b}$ B. 1
 C. $\frac{a-b}{a+b}$ D. $\frac{a^2-b^2}{a^2-b^2}$
14. If x varies inversely as the cube root of y and x = 1 when y = 8 find y when x = 3
 A. $\frac{1}{3}$ B. $\frac{2}{3}$
 C. $\frac{8}{27}$ D. $\frac{4}{9}$
15. If a = -3, b = 2, c = 4, calculate $\frac{(a^3-b^3-c^{1/2})}{(b-1-c)}$
 A. 37 B. -37/5
 C. 37/5 D. -37

16. If $g(y) = y - \frac{3}{11} + \frac{11}{y^2} - 9$ what is $g(y+3)$?

A. $\frac{y+11}{11y(y+6)}$ B. $\frac{y+11}{11y(y+3)}$
 C. $\frac{y+30}{11} + \frac{11}{y(y+3)}$ D. $\frac{y+3+11}{11y(y-6)}$

17. Factorize completely $(x^2+x)^2(2x+2)^2$
 A. $(x+y)(x+2)(x-2)$ B. $(x+y)^2(x-2)^2$
 C. $(x+1)^2(x+2)^2$ D. $(x+1)^2(x+2)^2(x-2)$

18. Simplify $\frac{(x-y)}{(x^{1/3}-y^{1/2})}$

A. $x^2 = xy + y^2$ B. $x^{2/3} + x^{1/3} + y^3$

C. $x^{2/3} - x^{1/3}y^{1/3} - y^{2/3}$ D. $x^2 - xy + y^2$

19. Solve the following equation for x

$$\frac{x^2 + 2x + 1}{r^2} = \frac{0}{r^1}$$

A. r^2 B. $\frac{1}{r^2}$
 C. $-\frac{1}{r^2}$ D. $\frac{1}{r}$

20. List the integral values of x which satisfy the inequality

$$1 < 5 < -2x < 7$$

A. -1,0,1,2 B. 0,1,2,3
 C. -1,0,1,2,3, D. -1,0,2,3

21. Given value that $\frac{3x-5y-3=0}{2y-6x+5=0}$

the value of (x, y) is

A. (-1/8, 19/24) B. (8, 24/10)
 C. (-8, 24/19) D. (19/24, -1/8)

22. The solution of the quadratic equation

$$bx^2 + qx + b = 0$$

A. $\frac{-b \pm \sqrt{b^2 - 4ac}}{2a}$ B. $\frac{-b \pm p^2 - 4pb}{2a}$
 C. $\frac{-q \pm \sqrt{q^2 - 4bp}}{2p}$ D. $\frac{-q \pm \sqrt{p^2 - 4bp}}{2p}$

23. Simplify $\frac{1}{(x^2+5x+6)} + \frac{1}{(x^2+3x+2)}$

A. $\frac{x+3}{(x+1)(x+2)}$ B. $\frac{1}{(x+1)(x+2)(x+3)}$
 C. $\frac{2}{(x+1)(x+3)}$ D. $\frac{4}{(x+1)(x+3)}$

24. Evaluate $\frac{(4a^2 - 4ab^2)}{(2a^2 + 5ab - 7b^2)}$

A. $\frac{a-b}{2a+b}$ B. $\frac{2a+7b}{a-b}$

C. $\frac{2a-7b}{a+b}$ D. $\frac{2a-7b}{a-b}$

Using the graph to answer questions 25 and 26

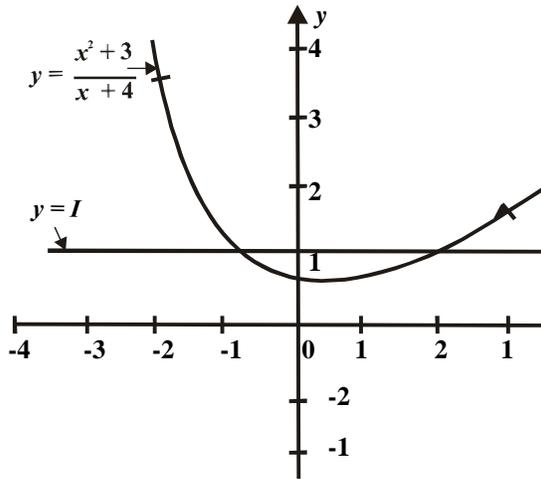

25. What is the solution of the equation $x^2 - x - 1 = 0$?
- A. $x = 1.6$ and $x = -0.6$ B. $x = -1.6$ and $x = 0.6$
 C. $x = 1.6$ and $x = 0.6$ D. $x = -1.6$ and $x = -0.6$

26. For what values of x is the curve $y = (x^2 + 3) / (x + 4)$
- A. $-3 < x < 0$ B. $-3 < x < 0$
 C. $0 < x < 3$ D. $0 < x < 3$

27. The solution of $x^2 - 2x - 1 = 0$ are the points of intersection of two graphs. If one of the graphs is $y = 2 + x - x^2$, find the second graph.
- A. $y = 1 - x$ B. $y = 1 + x$
 C. $y = x - 1$ D. $y = 3x + 3$

28. If the sum of the 8th and 9th terms of an arithmetic progression is 72 and the 4th term is -6, find the common difference.
- A. 4 B. 8
 C. $6\frac{2}{3}$ D. $9\frac{1}{3}$

29. If 7 and 189 are the first and fourth terms of a geometric progression respectively find the sum of the first three terms of the progression.
- A. 182 B. 91
 C. 63 D. 28

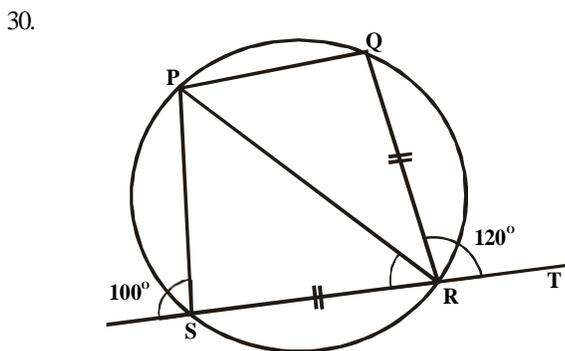

- In the figure above, PQRS is a circle. If chords QR and RS are equal, calculate the value of x
- A. 80° B. 60°
 C. 45° D. 40°

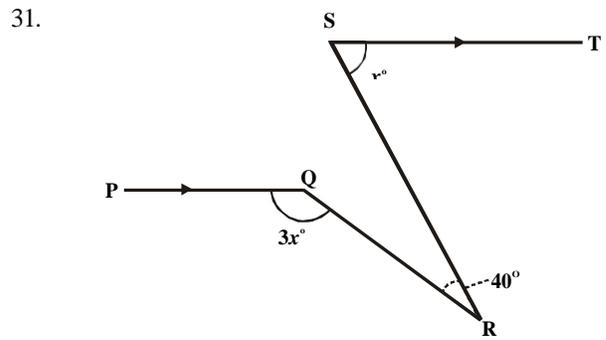

- In the figure above, PQ is parallel to ST and $\angle QRS = 40^\circ$. find the value of x
- A. 55 B. 60
 C. 65 D. 75

32. For which of the following exterior angles is a regular polygon possible?
- i 35° ii 18° iii 115°
- A. i and ii B. ii only
 C. ii and iii D. iii only

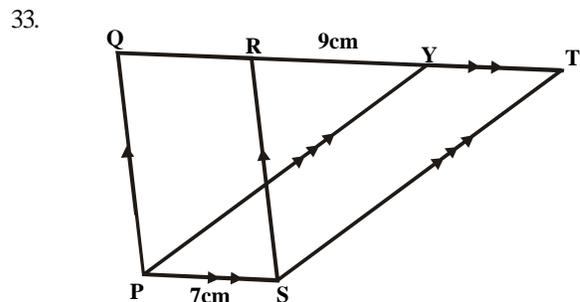

- In the figure above, $PS = 7\text{cm}$ and $RY = 9\text{cm}$. If the area of parallelogram PQRS is 56cm^2 , find the area of trapezium PQTS.
- A. 56cm^2 B. 112cm^2
 C. 120cm^2 D. 176^2

34. A quadrilateral of a circle of radius 6cm is cut away from each corner of a rectangle 25cm long and 18cm wide. Find the perimeter of the remaining figure
- A. 38cm B. $(38+12p)\text{cm}$
 C. $(86-12p)\text{cm}$ D. $(86-6p)\text{cm}$

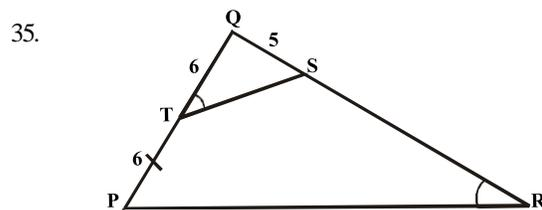

- In the figure above $\angle STQ = \angle SRP$, $PT = TQ = 6\text{cm}$ and $QS = 5\text{cm}$. Find SR.
- A. $47/5$ B. 5
 C. $37/5$ D. $22/5$

36. Four interior angles of a pentagon are $90^\circ - x^\circ$, $90^\circ + x^\circ$, $10^\circ - 2x^\circ$, $110^\circ + 2x^\circ$. find the fifth interior angle.
- A. 110° B. 120°
 C. 130° D. 140°

37.

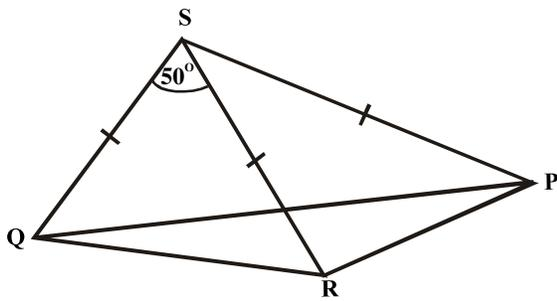

In the figure above, $PS = RS = QS$ and $QSR = 50^\circ$. find $\angle QPR$.

- A. 25° B. 40°
 C. 50° D. 65°

38.

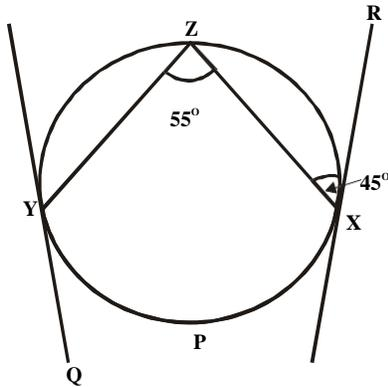

In the figure above, XR and YQ are tangents to the circle $YZXP$ if $\angle ZXR = 45^\circ$ and $\angle YZX = 55^\circ$ find $\angle ZYQ$.

- A. 135° B. 125°
 C. 100° D. 90°

39. From a point $14\sqrt{3}$ metres away from a tree, a man discovers that the angle of elevation of the tree is 30° . If the man measures this angle of elevation from a point 2meters above the ground how high is the tree?

- A. 12m B. 14m
 C. $14\sqrt{3}$ m D. 16m

40. Alero starts a 3km walk from P on a bearing 023° . she then walks 4km on a bearing 113° to Q what is the bearing of Q from P?

- A. $26^\circ 52'$ B. $52^\circ 8'$
 C. $76^\circ 8'$ D. 90°

41. If $\cot q = x/y$, find $\operatorname{cosec} q$

- A. $1/y(x^2+y)$ B. $\sqrt{x/y}$
 C. $1/y(x^2+y)$ D. y/x

42. In triangle PQR, $PQ = 1$ cm, $QR = 2$ cm and $\angle PQR = 120^\circ$. Find the longest side of the triangle

- A. 3 B. $\sqrt[3]{7}/7$
 C. $3\sqrt{7}$ D. $\sqrt{7}$

44. If a metal pipe 10cm long has an external diameter of 12cm and a thickness of 1cm, find the volume of the metal used in making the pipe.

- A. 120pcm^3 B. 110pcm^3
 C. 60pcm^3 D. 50pcm^3

45.

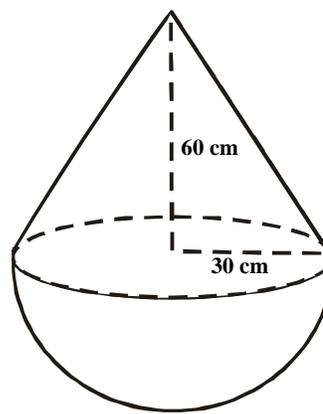

In the figure above, a solid consists of a hemisphere surmounted by a right circular cone with radius 3.0cm and height 6.0cm. find the volume of the solid.

- A. 18pcm^3 B. 36pcm^3
 C. 54pcm^3 D. 108pcm^3

46. PQR is a triangle in which $PQ = 10$ cm and $\angle QPR = 60^\circ$. S is a point equidistant from P and Q. also S is a point equidistant from PQ and PR. If U is the foot of the perpendicular from S on PR, find the length SU in cm to one decimal place.

- A. 2.7 B. 2.9
 C. 3.1 D. 3.3

47. In a class of 150 students, the sector in a pie chart representing the students offering Physics has angle 12° . How many students are offering Physics?

- A. 18 B. 15
 C. 10 D. 5

48. If x and y represents the mean and the median respectively of the following set of numbers; 11, 12,13,14,15,16,17,18,19,21,. Find x/y correct to one decimal place.

- A. 1.6 B. 1.2
 C. 1.1 D. 1.0

49.

Score (x)	0	1	2	3	4	5	6
Frequency (f)	7	11	6	7	7	5	3

In the distribution above, the mode and the median respectively are

- A. 1.3 B. 1.2
 C. 3.3 D. 0.2

50. If two dice are thrown together, what is the probability of obtaining at least a score of 10?

- A. $1/6$ B. $1/12$
 C. $5/6$ D. $11/12$

Mathematics 1989

- Which of the following is in descending order?
 A. $9/10, 4/5, 3/4, 17/10$ B. $4/5, 9/10, 3/4, 17/20$
 C. $6/10, 17/20, 4/5, 3/4$ D. $4/5, 9/10, 17/10, 3/4$
- Evaluate $2,700,000 \times 0.03$, $18,000$
 A. 4.5×10^0 B. 4.5×10^1
 C. 4.5×10^2 D. 4.5×10^3
- The prime factors of 2,520 are
 A. 2,9,5, B. 2,9,7,
 C. 2,3,5,7, D. 2,3,7,9,
- If $12 = X^e$ find x where e = 12
 A. 20^7 B. 15
 C. 14 D. 12
- Simplify $3\sqrt[3]{64r^{-6}}$ ^{1/2}
 A. r B. 2r
 C. $1/2r$ D. $2/r$
- What is the difference between 0.007685 correct to three significant figures and 0.007685 correct to four places of decimal?
 A. 10^{-5} B. 7×10^{-4}
 C. 8×10^{-5} D. 10^{-6}
- If a : b = 5 : 8, x : y = 25 : 16, evaluate a/x : b/y
 A. 125:128 B. 3:5
 C. 3:4 D. 2:5
- Oke deposited #800.00 in the bank at the rate of $12\frac{1}{2}\%$ simple interest. After some time the total amount was one and half times the principal. For how many years was the money left in the bank
 A. 2 B. 4
 C. $5\frac{1}{2}$ D. 8
- If the surface area of a sphere is increased by 44%. Find the percentage increase in its diameter.
 A. 44 B. 30
 C. 22 D. 20
- Simplify $4 - \frac{1}{(2-\sqrt{3})}$
 A. $2\sqrt{3}$ B. $2, \sqrt{3}$
 C. $-2 + \sqrt{3}$ D. $2, -\sqrt{3}$
- Find p in terms of q if $\log_3 p + 3\log q = 3$
 A. $(3)^3$ B. $(q)^{1/3}$
 C. $(q)^3$ D. $(3)^{1/3}$
 (3) (q)
- What are the values of y which satisfy the equation $9^y - 4(3y) + 3 = 0$
 A. -1 and 0 B. -1 and 1
 C. 1 and 3 D. 0 and 1
- Make R the subject of the formula $S = \sqrt{(2R+T)(3RT)}$
 A. $R = \frac{T}{(TS^2 - 1)}$ B. $\frac{T}{2(TS^2 - 1)}$
 C. $R = \frac{T}{(TS^2 + 1)}$ D. $\frac{T}{2(TS^2 + 1)}$
- Find the value of the expression $\frac{32}{81^{x^3}} - \frac{64}{x^{x^2}} - \frac{81}{16}$ when $x = -3/4$
 A. $10^{1/2}$ B. $10^{1/}$
 C. $3^3/8$ D. $-13^{3/2}$
- The cost of dinner for a group of students is partly constant and partly varies directly as the number of students. If the cost is #74.00 when the number of students is 20, and #96.00 when the number is 30, find the cost when there are 15 students.
 A. #68.50 B. #63.00
 C. #60.00 D. #52.00
- If $f(x) = 2x^2 + 5x + 3$, find $f(x+1)$
 A. $2x^2 - x$ B. $2x^2 - x + 10$
 C. $4x^2 + 3x + 2$ D. $4x^2 + 3x + 12$
- Solve the positive number x such that $2^{(x^3 - x^2 - 2x)} = 1$
 A. 4 B. 3
 C. 2 D. 1
- Simplify $\frac{(32x - 4x^2)}{(2x + 18)}$
 A. $2(x-9)$ B. $2(9+x)$
 C. $81 - x^2$ D. $-2(x-9)$
- Factorize completely $y^3 - 4xy + xy^3 - 4y$
 A. $(x + xy)(y + 2)(y - 2)$
 B. $(y + xy)(y + 2)(y - 2)$
 C. $y(1 + x)(y + 2)(y - 2)$
 D. $y(1 - x)(y + 2)(y - 2)$
- If one of $x^3 - 8^{-1}$ is $x - 2^{-1}$, the other factors is
 A. $x^2 + 2^{-1}x - 4^{-1}$ B. $x^2 - 2^{-1}x - 4^1$
 C. $x^2 + 2^{-1}x + 4^{-1}$ D. $x^2 + 2^{-1}x - 4^1$
- Factorize $4a^2 + 12ab - c^2 + 9b^2$
 A. $4a(a - 3b) + (3b - c)^2$
 B. $(2a + 3b - c)(2a + 3b + c)$
 C. $(2a - 3b - c)(2a - 3b + c)$
 D. $4a(a - 3b) + (3b + c)^2$
- What are K and L respectively if $\frac{1}{2}(3y - 4x)^2 = (8x^2 + kxy + Ly^2)$
 A. -12, 9/2 B. -6, 9
 C. 6, 9 D. 12, 9/2

23. Solve the pair of equation for x and y respectively

$$2x^{-1} - 3y^{-1} = 4$$

$$4x^{-1} + y^{-1} = 1$$

- A. -1,2 B. 1,2
C. 2,1 D. 2,-1

24. What value of Q will make the expression $4x^2 + 5x + Q$ a complete square?

- A. 25/16 B. 25/64
C. 5/8 D. 5/4

25. Find the range of values of r which satisfies the following inequality, where a, b and c are positive. $r/a+r/b+r/c > 1$

- A. $r > \frac{abc}{bc + ac + ab}$ B. $r > abc$
C. $r > 1/a + 1/b + 1/c$ D. $r > 1/abc$

26. Express $\frac{1}{(x+1)} - \frac{1}{(x-2)}$

- A. $\frac{-3}{(x+1)(2-x)}$ B. $\frac{3}{(x+1)2-x}$
C. $\frac{-1}{(x+1)(x-2)}$ D. $\frac{1}{(x+1)(x-2)}$

27. Simplify $\frac{x - (x+1)^{1/2}}{(x+1)(x+1)^{1/2}}$

- A. $\frac{1}{x+1}$ B. $-\frac{1}{x+1}$
C. $\frac{1}{x}$ D. $\frac{1}{x+1}$

28.

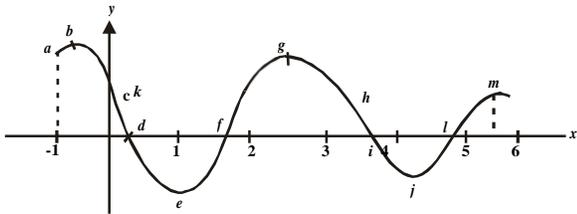

On the curve above, the points at which the gradient of the curve is equal to zero are

- A. c,d,f,i,l B. b,e,g,j,m
C. a,b,c,d,f,i,j,l D. c,d,f,h,i,l

29. The sum of the first two terms of a geometric progression is x and the sum of the last two terms is y. if there are n terms in all, then the common ratio is

- A. x/y B. y/x
C. $(x/y)^{1/2}$ D. $(y/x)^{1/2}$

30. If -8, m,n, 19 in arithmetic progression, find (m, n)

- A. 1,10 B. 2,10
C. 3,13 D. 4,16

31.

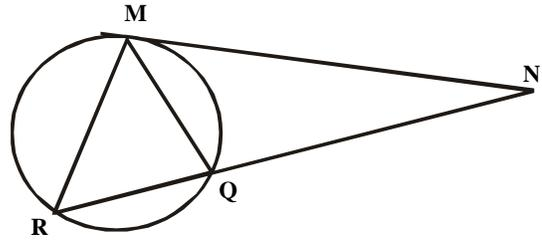

MN is a tangent to the given circle at M, MR and MQ are two chords. If $\angle QMN = 60^\circ$ and $\angle MNQ = 40^\circ$, find $\angle RMQ$

- A. 120° B. 11°
C. 60° D. 20°

32.

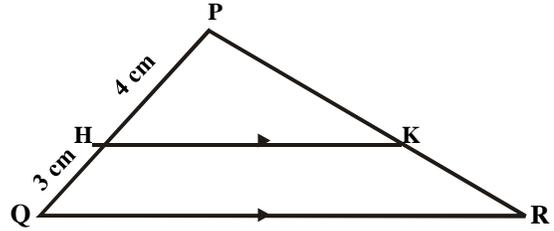

In the diagram above, HK is parallel to QR, PH = 4cm and HQ = 3cm. What is the ratio of KR:PR?

- A. 7:3 B. 3:7
C. 3:4 D. 4:3

33.

A regular polygon of $(2k + 1)$ sides has 140° as the size of each interior angle. Find K.

- A. 4 B. $4\frac{1}{2}$
C. 8 D. $8\frac{1}{2}$

34.

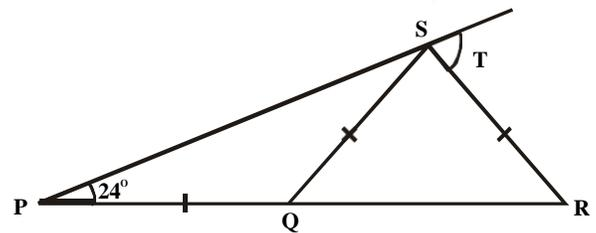

If PST is a straight line and $PQ = QS = SR$ in the above diagram, find y

- A. 24° B. 48°
C. 72° D. 84°

35.

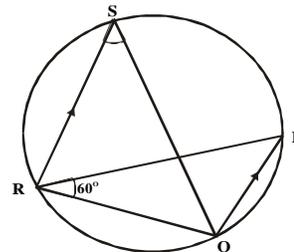

In the above diagram PQ is parallel to RS and QS bisects $\angle PQR$. If $\angle PQR = 60^\circ$, find x

- A. 30° B. 40°
C. 60° D. 120°

36.

PQRS is a rhombus. If $PR^2 + QS^2 = kPQ^2$. Determine k.

- A. 1 B. 2
C. 3 D. 4

37. In $\triangle XYZ$, $\angle Y = \angle Z = 30^\circ$ and $XZ = 3\text{cm}$ find YZ
 A. $\frac{\sqrt{3}}{2}\text{cm}$ B. $3\frac{\sqrt{3}}{2}\text{cm}$
 C. $3\sqrt{3}\text{cm}$ D. $2\sqrt{3}\text{cm}$

38. In $\triangle PQR$, the bisector of $\angle QPR$ meets QR at S . the line PQ is produced to V and the bisector of $\angle VQS$ meets PS produced at T . if $\angle QPR = 46^\circ$ and $\angle QST = 75^\circ$, calculate $\angle QTS$
 A. 41° B. 52°
 C. 64° D. 82°

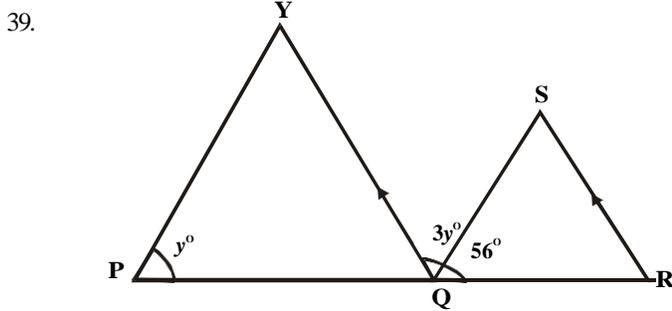

- A. If PQR is a straight line with $OS = QR$, calculate $\angle TPQ$, if $QT \parallel SR$ and $\angle TQS = 3y^\circ$.
 A. 62° B. 56°
 C. $20\frac{2}{3}^\circ$ D. $18\frac{2}{3}^\circ$

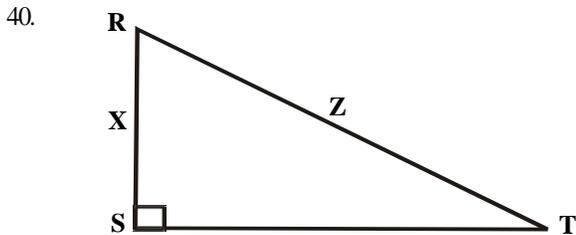

- If $x : y = 5 : 12$ and $z = 52\text{cm}$, find the perimeter of the triangle.
 A. 68cm B. 84cm
 C. 100cm D. 120cm

41. The pilot of an aeroplane, flying 10km above the ground in the direction of a landmark, views the landmark to have angle of depression of 35° and 55° . find the distance between the two points of observation
 A. $10(\sin 35^\circ - \sin 55^\circ)$
 B. $10(\cos 35^\circ - \cos 55^\circ)$
 C. $10(\tan 35^\circ - \tan 55^\circ)$
 D. $10(\cot 35^\circ - \cot 55^\circ)$

42. $A \sin^2 x - 3 = 0$, find x if $0 < x < 90^\circ$
 A. 30° B. 45°
 C. 60° D. 90°

43. A square tile has side 30cm . How many of these tiles cover a rectangular floor of length 7.2m and width 4.2m ?
 A. 336 B. 420
 C. 576 D. 720

44. A cylindrical metal pipe 1m long has an outer diameter of 7.2cm and an inner diameter of 2.8cm . find the volume of metal used for the cylinder.
 A. 440pcm^3 B. $1,100\text{pcm}^3$
 C. $4,400\text{pcm}^3$ D. $11,000\text{pcm}^3$

45.

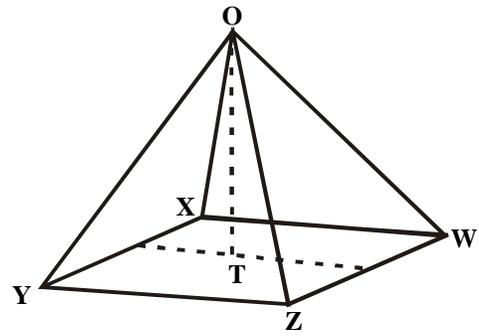

$OXYZW$ is a pyramid with a square base such that $OX = OY = OZ = OW = 5\text{cm}$ and $XY = XW = YZ = WZ = 6\text{cm}$. Find the height OT .

- A. $2\sqrt{5}$ B. 3
 C. 4 D. $\sqrt{7}$

46. In preparing rice cutlets, a cook used 75g of rice, 40g of margarine, 105g of meat and 20g of bread crumbs. Find the angle of the sector which represents meat in a pie chart.

- A. 30° B. 60°
 C. 112.5° D. 157.5°

47. In a class of 30 students, the marks scored in an examination are displayed in the following histogram.

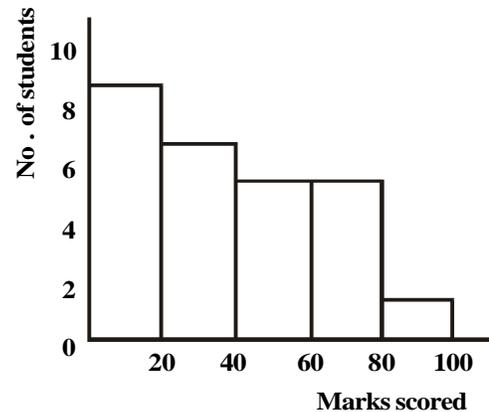

What percentage of the students scored more than 40%

- A. 14% B. 40%
 C. $45\frac{2}{3}\%$ D. $53\frac{1}{3}\%$

48. In a family of 21 people, the average age is 14 years. If the age of the grandfather is not counted, the average age drops to 12 years. What is the age of the grandfather?

- A. 35 years B. 40 years
 C. 42 years D. 54 years

49. If n is the median and m is the mode of the following set of numbers, $2, 4, 2, 1, 1, 6, 2, 6, 3, 7, 2, 1, 2, 6$, then (n, m) is

- A. $(2.6, 2.6)$ B. $(2.5, 2.6)$
 C. $(2.6, 2.5)$ D. $(2.5, 2.1)$

50. The numbers are chosen at random from three numbers $1, 3, 6$. find the probability that the sum of the two is not odd.

- A. $\frac{2}{3}$ B. $\frac{1}{2}$
 C. $\frac{1}{3}$ D. $\frac{1}{6}$

Mathematics 1990

- Simplify $\frac{(4^{3/4} - 6^{1/4})}{(4^{1/5} \text{ of } 1^{1/4})}$
 - $-\frac{7^7}{8}$
 - $-\frac{2}{7}$
 - $-\frac{10}{21}$
 - $\frac{10}{21}$
- The H.C.F. of $a^2bx + abx^2$ and $a^2b - b^3$ is
 - b
 - $a + b$
 - $a(a + b)$
 - $abx(a^2 - b^2)$
- Correct 241.34 (3×10^{-3})² to 4 significant figures
 - 0.0014
 - 0.001448
 - 0.0022
 - 0.002172
- At what rate would a sum of #100.00 deposited for 5 years raise an interest of #7.50?
 - $\frac{1}{2}\%$
 - $\frac{2}{2}\%$
 - 15%
 - 25%
- Three children shared a basket of mangoes in such a way that the first child took $\frac{1}{4}$ of the mangoes and the second $\frac{3}{4}$ of the remainder. What fraction of the mangoes did the third child take?
 - $\frac{3}{16}$
 - $\frac{7}{16}$
 - $\frac{9}{16}$
 - $\frac{13}{16}$
- Simplify and express in standard form $(0.00275 \times 0.00640) / (0.025 \times 0.08)$
 - 8.8×10^{-1}
 - 8.8×10^2
 - 8.8×10^{-3}
 - 8.8×10^3
- Three brothers in a business deal share the profit at the end of contract. The first received $\frac{1}{3}$ of the profit and the second $\frac{2}{3}$ of the remainder. If the third received the remaining #12,000.00, how much profit did they share?
 - #60,000.00
 - #54,000.00
 - #48,000.00
 - #42,000.00
- Simplify $\sqrt{160r^2} + \sqrt{71r^4} + \sqrt{100r^3}$
 - $9r^2$
 - $12\sqrt[3]{r}$
 - 13r
 - $\sqrt{13r}$
- Simplify $\sqrt{27} + 3/\sqrt{3}$
 - $4\sqrt{3}$
 - $4/\sqrt{3}$
 - $3\sqrt{3}$
 - $3\sqrt{4}$
- Simplify $3\text{Log}_6 9 + \text{Log}_6 12 + \text{Log}_6 64 - \text{Log}_6 72$
 - 5
 - 7776
 - $\text{Log}_6 31$
 - $(7776)^6$
- Simplify $\left(\frac{1}{x-1} + \frac{1}{y}\right)^{-1}$
 - x/y
 - xy
 - y/x
 - $(xy)^{-1}$
- If $a = 2$, $b = -2$ and $c = -1/2$, evaluate $(ab^2 - bc^2)(a^2c - abc)$
 - 0
 - 28
 - 30
 - 34
- Y varies inversely as x^2 and X varies directly as Z^2 . find the relationship between Y and Z, if C is a constant.
 - $Z^2y = C$
 - $Y = CZ^2$
 - $Y = CZ^2$
 - $Y = C$
- Find the value of r in terms of p and q in the following equation $P/2 = (r/(r+q))$
 - $r = \frac{q}{2 - p^2}$
 - $\frac{pq^2}{2 - q^2}$
 - $r = \frac{p^2q^2}{2 - pq}$
 - $\frac{p}{q(2-p)}$
- If $f(x - 4) = x^2 + 2x + 3$, find $f(2)$
 - 6
 - 11
 - 27
 - 51
- Factorize $9(x + y)^2 - 4(x - y)^2$
 - $(x + y)(5x + y)$
 - $(x + y)^2$
 - $(x + 5y)(5x + y)$
 - $5(x + y)^2$
- If $a^2 + b^2 = 16$ and $2ab = 7$ find all the possible values of $(a - b)$
 - 3, -3
 - 2, -2
 - 1, -1
 - 3, -1
- Divide $x^3 - 2x^2 - 5x + 6$ by $(x - 1)$
 - $x^2 - x - 6$
 - $x^2 - 5x + 6$
 - $x^2 - 7x + 6$
 - $x^2 - 5x - 6$
- If $x + = 4$, find the $x^2 + 1/x$
 - 16
 - 14
 - 12
 - 9
- What must be added to $4x^2 - 4$ to make it a perfect square?
 - $-1/x^2$
 - $1/x^2$
 - 1
 - 1
- Find the solution of the equation $x - 8\sqrt{x} + 15 = 0$
 - 3, 5
 - 3, -5
 - 9, 25
 - 9, 25
- The lengths of the sides of a right-angled triangle are xcm, $(3x-1)$ cm and $(3x + 1)$ cm. Find x
 - 5
 - 7
 - 8
 - 12
- The perimeter of a rectangular lawn is 24m, if the area of the lawn is 35m^2 , how wide is the lawn?
 - 5m
 - 7m
 - 12m
 - 14m

25. Simplify $\frac{x}{(x+y)} + \frac{y}{(x-y)} - \frac{x^2}{(x^2 - y^2)}$
- A. $\frac{x^2}{x^2 - y^2}$ B. $\frac{y^2}{x^2 - y^2}$
 C. $\frac{x}{x^2 - y^2}$ D. $\frac{y}{x^2 - y^2}$

26. Given that $x^2 + y^2 + z^2 = 194$, calculate z if $x = 7$ and $\sqrt{y} = 3$
- A. $\sqrt{10}$ B. 8
 C. 12.2 D. 13.4

27. Find the sum of the first twenty terms of the arithmetic progression $\log a, \log a^2, \log a^3$
- A. $\log a^{20}$ B. $\log a^{21}$
 C. $\log a^{200}$ D. $\log a^{210}$

24. A carpenter charges #40.00 per day for himself and #10.00 per day for his assistant. If a fleet of cars were painted for #2,000.00 and the painter worked 10 days more than his assistant, how much did the assistant receive?
- A. #32.00 B. #320.00

28. Find the sum of the first 18 terms of the progression 3, 6, 12,
- A. $3(2^{17} - 1)$ B. $3(2^{18} - 1)$
 C. $3(2^{18} + 1)$ D. $3(2^{18} - 1)$

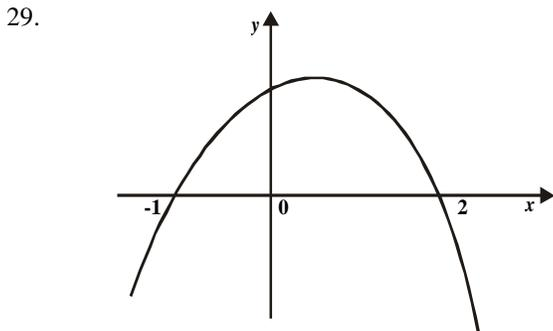

What is the equation of the quadratic function represented by the graph above?

- A. $y = x^2 + x - 2$ B. $y = x^2 - x - 2$
 C. $y = -x^2 - x + 2$ D. $y = -x + x + 2$
30. At what value of x is the function $x^2 + x + 1$ minimum?
- A. -1 B. -1/2
 C. 1/2 D. 1

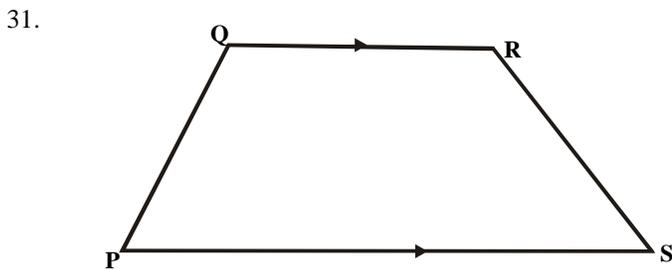

In the diagram above, the area of PQRS is 73.5cm^2 and its height is 10.5cm. find the length of PS if QR is one-third of PS.

- A. 21cm B. $17\frac{1}{2}\text{cm}$
 C. 14cm D. $10\frac{1}{2}\text{cm}$

32. The angle of a sector of a circle, radius 10.5cm, is 48° . calculate the perimeter of the sector
- A. 8.8cm B. 25.4cm
 C. 25.6cm D. 29.8cm

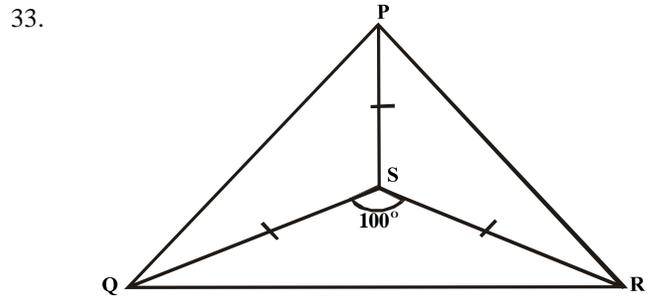

In the figure above $PS = QS$ and $QSR = 100^\circ$, find $\angle QPR$

- A. 40° B. 50°
 C. 80° D. 100°

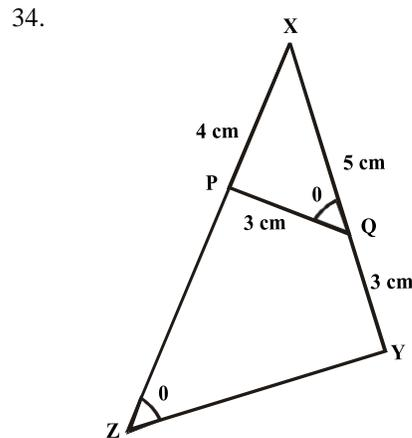

In triangle XYZ and XQP, $XP = 4\text{cm}$, $XQ = 5\text{cm}$ and $PQ = QY = 3\text{cm}$. Find ZY

- A. 8cm B. 6cm
 C. 4cm D. 3cm

35. Find the length of a side of a rhombus whose diagonals are 6cm and 8cm.

- A. 8cm B. 5cm
 C. 4cm D. 3cm

36. Each of the interior angles of a regular polygon is 140° . how many sides has the polygon?

- A. 9 B. 8
 C. 7 D. 5

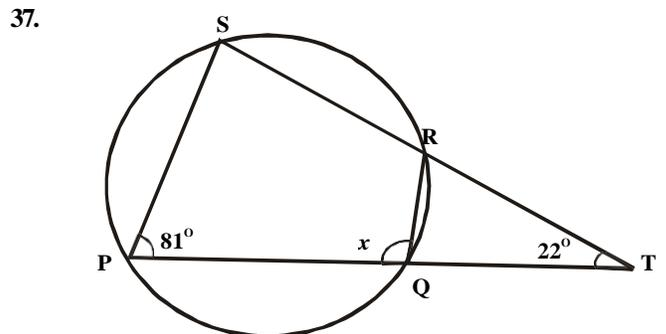

In the figure above, PQRS is a circle. If PQT and SRT are straight lines, find the value of x.

- A. 59° B. 77°
 C. 103° D. 121°

38. In a regular pentagon, PQRST, PR intersects QS at O. calculate RQS.
 A. 36° B. 72°
 C. 108° D. 144°

39. If $\cos q = 12/13$, find $1 + \cot^2 q$
 A. $169/25$ B. $25/169$
 C. $169/144$ D. $144/169$

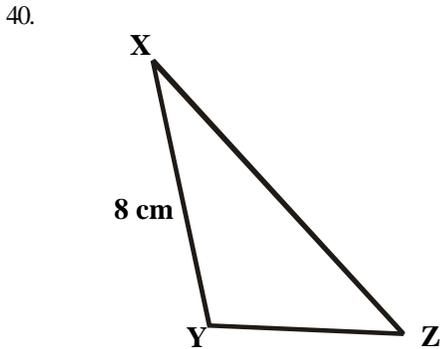

- In the figure above, $\angle YXZ = 30^\circ$, $\angle XYZ = 105^\circ$ and $XY = 8\text{cm}$. Calculate YZ .
 A. $16\sqrt{2}\text{cm}$ B. $8\sqrt{2}\text{cm}$
 C. $4\sqrt{2}\text{cm}$ D. $2\sqrt{2}\text{cm}$

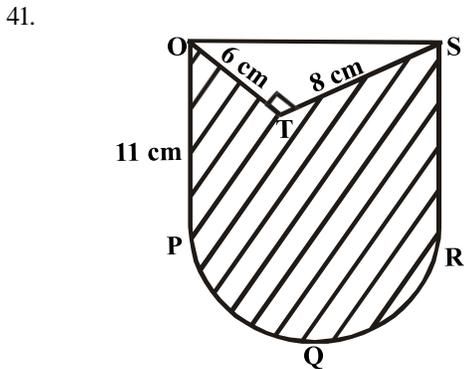

- In the figure above PQR is a semicircle. Calculate the area of the shaded region.
 A. $125/\text{cm}^2$ B. $149^2/\text{cm}^2$
 C. $243^{1/7}/\text{cm}^2$ D. $267^{1/2}/\text{cm}^2$

42. A cylindrical pipe, made of metal is 3cm, thick if the internal radius of the pipe is 10cm. Find the volume of metal used in making 3m of the pipe
 A. $153\pi\text{cm}^3$ B. $207\pi\text{cm}^3$
 C. $15,300\pi\text{cm}^3$ D. $20,700\pi\text{cm}^3$

43. If the height of two circular cylinders are in the ratio 2:3 and their base radii are in the ratio 9. what is the ratio of their volume
 A. 27:32 B. 27:23
 C. 23:32 D. 21:27

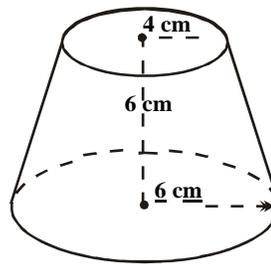

- Find the curved surface area of the frustum in the figure.
 A. $16\sqrt{10}\text{cm}$ B. $20\sqrt{10}$
 C. 24 D.

45. The locus of a point which moves so that it is equidistant from two intersecting straight lines is the
 A. perpendicular bisector of the two lines
 B. angle bisector of the two lines
 C. bisector of the two lines
 D. line parallel to the two lines

46. 4, 16, 30, 20, 10, 14 and 26 are represented on a pie chart. Find the sum of the angles of the sectors representing all numbers equal to or greater than 16.
 A. 48° B. 84°
 C. 92° D. 276°

47. The mean of ten positive numbers is 16. when another number is added, the mean becomes 18. find the eleventh number.
 A. 3 B. 16
 C. 18 D. 30

48. Below are the scores of a group of students in a test.

Scores	1	2	3	4	5	6
No. of students	1	4	5	6	x	2

- If the average score is 3.5, find the value of x.
 A. 1 B. 2
 C. 3 D. 4

49. Two numbers are removed at random from the numbers 1,2,3 and 4. what is the probability that the sum of the numbers removed is even?
 A. $2/3$ B. $1/2$
 C. $1/3$ D. $1/4$

50. Find the probability that a number selected at random from 41 to 56 is a multiple of 9
 A. $1/9$ B. $2/15$
 C. $3/16$ D. $7/8$

Mathematics 1991

- Simplify $3^{1/3} - 1^{1/4} \times 2^{2/3} + 1^{2/3}$
 A. $2^{17/30}$ B. $3^{9/10}$
 C. $4^{1/10}$ D. $4^{11/36}$
- If 2257 is the result of subtracting 4577 from 7056 in base n, find n.
 A. 8 B. 9
 C. 10 D. 11
- Find correct to 3 decimal places
 $(\frac{1}{0.05} \div \frac{1}{5.005} - (0.05 \times 2.05))$
 A. 99.998 B. 98.999
 C. 89.899 D. 9.998
- Express $62/3$ as a decimal correct to 3 significant figures.
 A. 20.6 B. 20.667
 C. 20.67 D. 20.7
- Factory P produces 20,000 bags of cement per day while factory Q produces 15,000 bags per day. If P reduces production by 5% and Q increases production by 5% determine the effective loss in the number of bags produced per day by the two factories.
 A. 250 B. 750
 C. 1000 D. 1250
- Musa borrows #10.00 at 2% per month interest and repays #8.00 after 4 months. However much does he still owe?
 A. #10.80 B. #10.67
 C. #2.80 D. #2.67
- If 3 gallons of spirit containing 20% water are added to 5 gallons of another spirit containing 15% water, what percentage of the mixture is water?
 A. $2\frac{4}{8}\%$ B. $16\frac{7}{8}\%$
 C. $18\frac{5}{8}\%$ D. $18\frac{7}{8}\%$
- What is the product of $27/5 - (3)^3$ and $(1/5)$?
 A. 5 B. 3
 C. 1 D. $1/25$
- Simplify $2\log 2/5 - \log 72/125 + \log 9$
 A. $1 - 4\log 3$ B. $-1 + 2\log 3$
 C. $-1 + 5\log 2$ D. $1 - 2\log 2$
- Rationalize $(2\sqrt{3} + 3\sqrt{2})/(3\sqrt{2} - 2\sqrt{3})$
 A. $5 - 2\sqrt{6}$ B. $5 + 2\sqrt{6}$
 C. $5\sqrt{3}$ D. 5
- Simplify $(1/3 + \sqrt{5}) - 1/3 - \sqrt{5}$
 A. $-1/2\sqrt{5}$ B. $1/2\sqrt{5}$
 C. $-1/4\sqrt{5}$ D. 0
- Multiply $(x^2 - 3x - 1)^2$ by $(x - a)$
 A. $x^3 - (3 - a)x^2 + (1 + 3a)x - 1$
 B. $x^3 - (3 - a)x^2 + 3ax - a$
 C. $x^3 - (3 - a)x^2 + (1 + 3a) - a$
 D. $x^3 + (3 - a)x^2 + (1 + 3a) - a$
- Evaluate $\frac{(Xy^2 - X^2y)}{(x^2 - xy)}$
 when $x = -2$ and $y = 3$
 A. -3 B. $-3/5$
 C. $3/5$ D. 3
- A car travels from Calabar to Enugu, a distant of pkm with an average speed of ukm per hour and continues to Benin, a distance of qkm, with an average speed of wkm per hour. Find its average speed from Calabar to Benin.
 A. $(p+q)/(up+wq)$ B. $u+w$
 C. $uw(p+q)/(wp+uq)$ D. $(wp+uq)/(u+wq)$
- If w varies inversely as $uv/u + v$ and is equal to 8 when $u = 2$ and $v = 6$, find a relationship between u, v, w.
 A. $upw = 16(u + t)$ B. $16ur = 3w(u + t)$
 C. $upw = 12(u + t)$ D. $12upw = u + r$
- If $g(x = x^2 + 3x)$ find $g(x + 1) - g(x)$
 A. $(x + 2)$ B. $2(x + 2)$
 C. $(2x + 1)$ D. $(x + 4)$
- Factorize $m^3 - m^2 - m + 2$
 A. $(m^2 + 1)(m - 2)$
 B. $(m + 1)(m + 1)(m + 2)$
 C. $(m + 1)(m + 1)(m - 2)$
 D. $(m^2 + 2)(m - 1)$
- Factorize $1 - (a - b)^2$
 A. $(1 - a - b)(1 - a - b)$ B. $(1 - a + b)(1 + a - b)$
 C. $(1 - a + b)(1 - a + b)$ D. $(1 - a - b)(1 + a - b)$
- Which of the following is a factor of $rs + tr - pt - ps$?
 A. $(p - s)$ B. $(s - p)$
 C. $(r - p)$ D. $(r + p)$
- Find the two values of y which satisfy the simultaneous equation $3x + y = 8$
 $x^2 + xy = 6$
 A. -1 and 5 B. -5 and 1
 C. 1 and 5 D. 1 and 1
- Find the range of values of x which satisfy the inequality $(x/2 + x/3 + x/4) < 1$
 A. $x < 12/13$ B. $x < 13$
 C. $x < 9$ D. $x < 13/12$
- Find the positive number n, such that thrice its square is equal to twelve times the number.
 A. 1 B. 2
 C. 3 D. 4
- Solve the equation $(x - 2)(x - 3) = 12$
 A. 2,3 B. 3,6
 C. -1,6 D. 1,6

24. Simplify $\frac{\sqrt{1+x} + \sqrt{x}}{(\sqrt{1+x} - \sqrt{x})}$
 A. $1 - 2x - 2\sqrt{x}(1+x)$ B. $1 + 2x + 2\sqrt{x}(1+x)$
 C. $\sqrt{x}(1+x)$ D. $1 + 2x - 2\sqrt{x}(1+x)$
25. Evaluate $x^2(x^2 - 1)^{1/2} - (x^2 - 1)^{1/2}$
 A. $(x^2 - 1)^{1/2}$ B. $(x^2 - 1)$
 C. $(x^2 - 1)^{-1}$ D. $(x^2 - 1)^{-1/2}$
26. Find the gradient of the line passing through the points $(-2,0)$ and $(0, -4)$
 A. 2 B. 4
 C. -2 D. 4
27. At what value of x is the function $y = x^2 - 2x - 3$ minimum?
 A. 1
 B. 1
 C. 4
 D. 4
28. What is the n th term of the progression 27, 9, 3, ?
 A. $27(1/3)^{n-1}$ B. 3^{n+2}
 C. $27 + 18(n-1)$ D. $27 + 6(n-1)$
29. Find the sum of the 20 term in an arithmetic progression whose first term is 7 and last term is 117
 A. 2480 B. 1240
 C. 620 D. 124

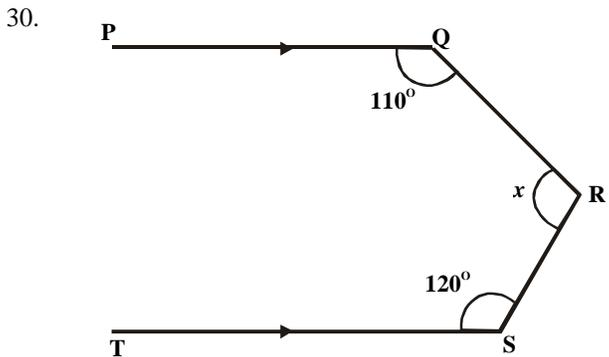

In the figure above, find the value of x
 A. 130° B. 110°
 C. 100° D. 90°

31. The angles of a quadrilateral are $5x - 30$, $4x + 60$, $60 - x$ and $3x + 61$. find the smallest of these angles.
 A. $5x - 30$ B. $4x + 60$
 C. $60 - x$ D. $3x + 61$.
32. The area of a square is 144sqcm. Find the length of its diagonal
 A. $11\sqrt{3}$ cm B. 12cm
 C. $12\sqrt{2}$ cm D. 13cm
33. One angle of a rhombus is 60° . the shorter of the two diagonals is 8cm long. Find the length of the longer one
 A. $8\sqrt{3}$ B. $16\sqrt{3}$
 C. $5\sqrt{3}$ D. $10\sqrt{3}$

34. If the exterior angles of a pentagon are x° , $(x + 5)^\circ$, $(x + 10)^\circ$, $(x + 15)^\circ$ and $(x + 20)^\circ$, find x
 A. 118° B. 72°
 C. 62° D. 36°

use the figure below to answer questions 35 and 36

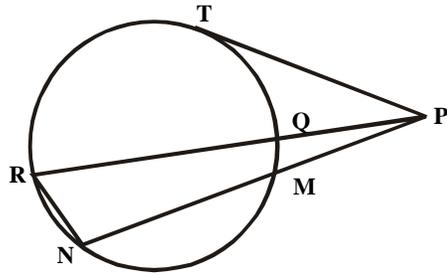

PMN and PQR are two secants of the circle MQTRN and PT is a tangent

35. If $PM = 5$ cm, $PN = 12$ cm and $PQ = 4.8$ cm, calculate the respective lengths of PR and PT in centimeters.
 A. 7.3, 5.9 B. 7.7, 12.5
 C. 12.5, 7.7 D. 5.9, 7.3 36.
 If $\angle PNR = 110^\circ$ and $\angle PMQ = 55^\circ$, find $\angle MPQ$.
 A. 40° B. 30°
 C. 25° D. 15°

37.

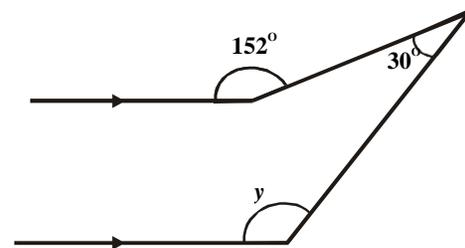

In the figure above, find the value of y
 A. 28° B. 122°
 C. 150° D. 152°

38.

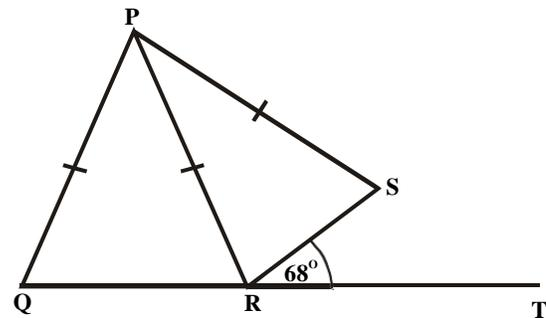

In the figure above, $PQ = PR = PS$ and $\angle SRT = 68^\circ$. find $\angle QPS$.

- A. 136° B. 124°
 C. 112° D. 68°
39. A flagstaff stands on the top of a vertical tower. A man standing 60m away from the tower observes that the angles of elevation of the top and bottom of the flagstaff are 64° and 62° respectively. Find the length of a flagstaff.
 A. $60(\tan 62^\circ - \tan 64^\circ)$
 B. $60(\cot 64^\circ - \cot 62^\circ)$
 C. $60(\cot 62^\circ - \cot 64^\circ)$
 D. $60(\tan 64^\circ - \tan 62^\circ)$

40. Simplify $\cos^2 x (\sec^2 x + \sec^2 x \tan^2 x)$
 A. $\tan x$ B. $\tan x \sec x$
 C. $\sec^2 x$ D. $\text{Cosec}^2 x$

41. If $\cos x = \sqrt{a/b}$, find $\text{cosec } x$.
 A. $\frac{b}{\sqrt{b-a}}$ B. $\sqrt{\frac{b}{a}}$
 C. $\frac{b}{\sqrt{b-a}}$ D. $\sqrt{\frac{b-a}{a}}$

42. From a point Z, 60m, north of X, a man walks 60Ö3m eastwards to another point Y. find the bearing of y from x
 A. 030° B. 045°
 C. 060° D. 090°

43. A surveyor walks 500m up a hill which slopes at an angle of 30°. calculate the vertical height through which he rises
 A. 250m B. 500Ö3/3m
 C. 250Ö2m D. 250Ö3m

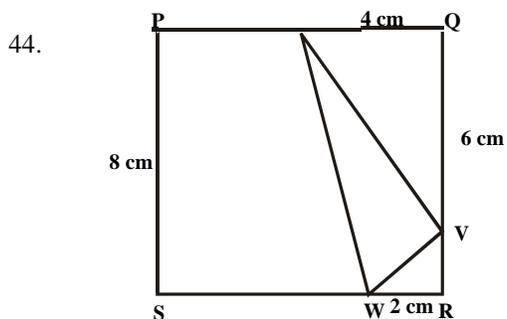

In the figure above, PQRS is a square of side 8cm. What is the area of $\triangle UVW$?

- A. 64sq.cm B. 54sq.cm
 C. 50sq.cm D. 10sq.cm

45. Find the total area of the surface of a solid cylinder whose base radius is 4cm and height is 5cm.
 A. 56pcm² B. 72pcm²
 C. 96pcm² D. 192pcm²

46.

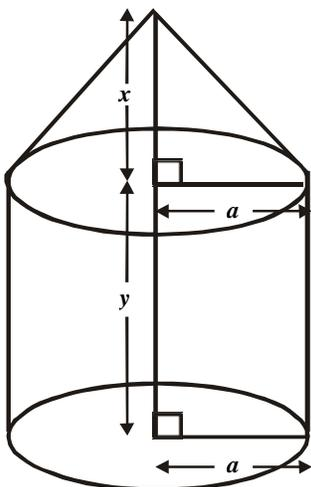

Find the volume of the figure above.

- A. $\frac{pa^2}{3}$ B. pa^2y
 C. $\frac{pa^2}{3}(y+x)$ D. $(\frac{1}{3}pa^2x + y)$

47. 3% of a family's income is spent on electricity. 9% on food. 20% on transport, 11% on education and 7% on extended family. The angles subtended at the centre of the pie chart under education and food are respectively
 A. 76.8° and 25.2° B. 10.8° and 224.6°
 C. 112.4° and 72.0° D. 39.6° and 212.4°

Use the following information to answer question 48 and 49.

No of defective per box	4	5	6	7	8	9
No . of boxes	2	7	17	10	8	6

Fifty boxes each of 50balls were inspected for the number which were defective. The following was the result

48. The mean and the median of the distribution are respectively
 A. 6.7,6 B. 6.7,6.5
 C. 6,6.7 D. 6.5,6.7
49. Find the percentage of boxes containing at least 5 defective bolts each.
 A. 96 B. 94
 C. 92 D. 90
50. A crate of soft drinks contains 10bottles of Coca-cola, 8 of Fanta and 6 of Sprite. If one bottle s selected at random, what is the probability that it is NOT a Coca cola bottle?
 A. 5/12 B. 1/3
 C. ¾ D. 7/1

Mathematics 1992

1. Find n if $34_n = 10011_2$
 - A. 5
 - B. 6
 - C. 7
 - D. 8

2. The radius of a circle is given as 5cm subject to an error of 0.1cm. what is the percentage error in the area of the circle.
 - A. 1/25
 - B. 1/4
 - C. 4
 - D. 25

3. Evaluate $\text{Log}_a a^n$ if $b = 1/a^n$
 - A. n^2
 - B. n
 - C. $1/n$
 - D. $1/n$

4. What is the value of x satisfying the equation $4^{2y} / 4^{3x} = 2?$
 - A. -2
 - B. -1/2
 - C. 1/2
 - D. 2

5. Simplify $\frac{(1.25 \times 10^4) \times (2.0 \times 10^{-1})}{(6.25 \times 10^5)}$
 - A. 4.0×10^{-3}
 - B. 5.0×10^{-2}
 - C. 2.0×10^{-1}
 - D. 5.0×10^3

6. Simplify $5\sqrt{18} - 3\sqrt{72} + 4\sqrt{50}$
 - A. $17\sqrt{4}$
 - B. $4\sqrt{17}$
 - C. $17\sqrt{2}$
 - D. $12\sqrt{4}$

7. If $x = 3 - \sqrt{3}$, find $x^2 + 36/x^2$
 - A. 9
 - B. 18
 - C. 24
 - D. 27

8. If $x = \{\text{all prime factors of } 44\}$ and $y = \{\text{all prime factors of } 60\}$, the elements of $x \cap y$ and $x \cup y$ respectively are.
 - A. $\{2,4,3,5,11\}$ and $\{4\}$
 - B. $\{4,3,5,11\}$ and $\{3,4\}$
 - C. $\{2,5,11\}$ and $\{2\}$
 - D. $\{2,3,5,11\}$ and $\{2\}$

9. If $U = \{0,2,3,6,7,8,9,10\}$ is the universal set, $E = \{0,4,6,8\}$ and $F = \{x: x^2 = 2^6, x \text{ is odd}\}$. Find $(E \cap F)'$ where means the complement of a set
 - A. $\{0\}$
 - B. U
 - C. C
 - D. f

10. Make l the subject of the formula $s = ut + \frac{1}{2}at^2$
 - A. $1/a [u \pm \sqrt{(u^2 - 2as)}]$
 - B. $1/a [-u \pm \sqrt{(u^2 - 2as)}]$
 - C. $1/a [u \pm \sqrt{(u^2 + 2as)}]$
 - D. $1/a [-u \pm \sqrt{(u^2 + 2as)}]$

11. Factorize $9p^2 - q^2 + 6pr - 9r^2$
 - A. $(3p - 3q + r)(3p - q - 9r)$
 - B. $(6p - 3q + 3r)(3p - q - 4r)$
 - C. $(3p - q + 3r)(3p + q - 3r)$
 - D. $(3p - q + 3r)(3p - q - 3r)$

12. Solve the equation $y - 11\sqrt{y} + 24 = 0$
 - A. 8,3
 - B. 64,9
 - C. 6,4
 - D. 9,-8

13. A man invested a sum of #280.00 partly at 59% and partly at 4%. If the total interest is #12.80 per annum, find the amount invested at 5%.
 - A. #14.00
 - B. #120.00
 - C. #140.00
 - D. #160.00

14. If $x + 1$ is a factor of $x^3 + 3x^2 + kx + 4$, find the value of k
 - A. 6
 - B. 6
 - C. 8
 - D. 8

15. Resolve $(3/x^2 + x - 2)$ into partial fractions
 - A. $\frac{1}{x-1} - \frac{1}{x+2}$
 - B. $\frac{1}{x+2} - \frac{1}{x-1}$
 - C. $\frac{1}{x+1} - \frac{1}{x-2}$
 - D. $\frac{1}{x-2} + \frac{1}{x+1}$

16. Find all values of x satisfying the inequality $-1 \leq 43x \leq 28$
 - A. $-5 \leq x \leq 18$
 - B. $5 \leq x \leq 8$
 - C. $-8 \leq x \leq 5$
 - D. $-5 < x \leq 8$

17.

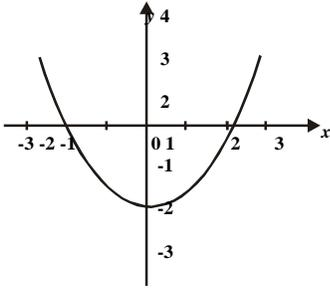

The sketch above is the curve of $y = ax^2 + bx + c$. find a , b , and c respectively

 - A. 1,0,-4
 - B. -2,-2,-4
 - C. 0,1,-4
 - D. 2,-2,-4

18. Find the sum of the infinity of the following series. $3 + 2 + 4/3 + 8/9 + 16/27 + ..$
 - A. 1270
 - B. 190
 - C. 18
 - D. 9

19. What is the n th term of the sequence 2,6,12,20,...?
 - A. $4n - 2$
 - B. $2(3n - 1)$
 - C. $n^2 + n$
 - D. $n^2 + 3n + 2$

20. For an arithmetic sequence, the first term is 2 and the common difference is 3. find the sum of the first 11 terms.

- A. 157 B. 187
C. 197 D. 200

21. If the binary operation $*$ is defined by $m*n = mn + m + n$ for any real number m and n , find the identity element under this operation.
A. $e = 1$ B. $e = -1$
C. $e = -2$ D. $e = 0$

Use the matrices below to answer questions 22 and 23.

22. When P^T is the transpose of P , calculate $[P^T]$ when $x = 0$, $y = 1$ and $z = 2$
A. 48 B. 24
C. -24 D. 48

23. PQ is equivalent to
A. PP^T B. PP^{-T}
C. QP D. PP

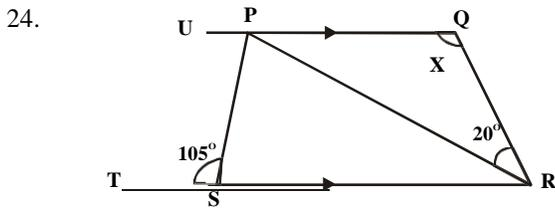

In the figure above, $TSP = 105^\circ$ and $PRQ = 20^\circ$, find PQR

- A. 130° B. 120°
C. 75° D. 30°
25. If the angles of a quadrilateral are $(p + 10)^\circ$, $(p + 20)^\circ$ and $4p^\circ$, find p
A. 63 B. 40
C. 36 D. 28

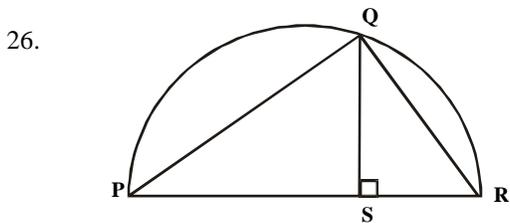

In the figure above, PQR is a semicircle while PQ and QR are chords. QS is the perpendicular from Q to the diameter PR . What is the expression for QS ?

- A. $QS = PS.SR$
B. $QS = \sqrt{PS.SR}$
C. $QS = \sqrt{2} \sqrt{PS.SR}$
D. $QS = 1/\sqrt{2} \sqrt{PS.SR}$
27. Determine the distance on the earth's surface between two towns P (Lat. $60^\circ N$, Long. $20^\circ E$) and Q (Lat. $60^\circ N$, Long $25^\circ W$)
A. $800p/9km$ B. $800\sqrt{3}p/9km$
C. $800pkm$ D. $800\sqrt{3}pkm$

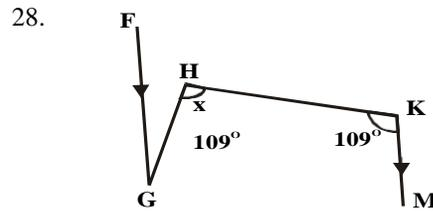

If in the diagram above, FG is parallel to KM , find the value of x

- A. 75° B. 95°
C. 105° D. 125°
29. X is a point due east of point Y on a coast Z is another point on the coast but $6.3km$ due south of Y . if the distance ZX is $12km$, calculate the bearing of Z from X
A. 240° B. 210°
C. $150^\circ 08'$ D. 60°

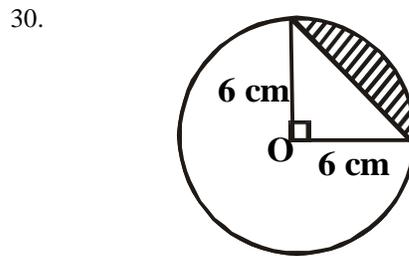

The above diagram is a circle with centre O . find the area of the shaded portion.

- A. $9\pi cm^2$ B. $9(\pi - 2)cm^2$
C. $18\pi cm^2$ D. $36\pi cm^2$
31. The locus of a point which is equidistant from two given fixed points is the
A. perpendicular bisector of the straight line joining them
B. parallel line to the straight line joining them
C. transverse to the straight line joining them
D. angle bisector of 90° which the straight line joining them makes with the horizontal

32. What is the perpendicular distance of a point $(2, 3)$ from the line $2x - 4y + 3 = 0$
A. $\sqrt{5}/2$ B. $-\sqrt{5}/20$
C. $-5/\sqrt{13}$ D. 0

33. Find the equation of the line through $(5, 7)$ parallel to the line $7x + 5y = 12$
A. $5x + 7y = 120$ B. $7x + 5y = 70$
C. $x + y = 7$ D. $15x + 17y = 90$

34. Given that q is an acute angle and $\sin q = m/n$, find $\cot q$.

- A. $\sqrt{\frac{n^2 - m^2}{m}}$ B. $\sqrt{\frac{(n + m)(n - m)}{m}}$
C. $\frac{m}{\sqrt{n^2 - m^2}}$ D. $\sqrt{\frac{n}{n^2 - m^2}}$

35.

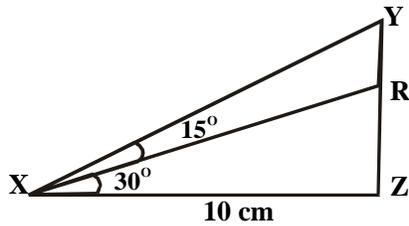

In the figure above, if XZ is 10cm, calculate RY in cm

- A. 10 B. $10(1 - \frac{1}{\sqrt{3}})$
 C. $10(1 - \sqrt{3})$ D. $10(1 - \frac{1}{\sqrt{2}})$

36.

Evaluate $\lim_{x \rightarrow 2} \frac{(x-2)(x^2+3x-2)}{(x^2-4)}$

- A. 0 B. 2
 C. 3 D. 4

37.

If $y = x$, find d^2y/dx^2

- A. $2 \cos x - x \sin x$ B. $\sin x + x \cos x$
 C. $\sin x - x \cos x$ D. $x \sin x - 2 \cos x$

38.

Ice forms on a refrigerator ice-box at the rate of $(4 - 0.6t)$ g per minute after t minute. If initially there are 2g of ice in the box, find the mass of ice formed in 5 minutes.

- A. 19.5 B. 17.0
 C. 14.5 D. 12.5

39.

Obtain a maximum value of the function

$$f(x) = x^3 - 12x + 11$$

- A. -5 B. -2
 C. 5 D. 27

40.

A student blows a balloon and its volume increases at a rate of $p(20 - t^2)$ ccm³s⁻¹ after t seconds. If the initial volume of 0cm³, find the volume of the balloon after 2 seconds.

- A. 37.00π B. 37.33π
 C. 40.00π D. 42.67π

41.

Evaluate the integral $\int \pi^4 \pi / 12 \cos 2x dx$

- A. -1/2 B. -1
 C. 1/2 D. 1

42.

A storekeeper checked his stock of five commodities and arrived at the following statistics.

Commodity	Quantity
F	215
G	113
H	108
K	216
M	68

What angle will commodity H represent on a pie chart?

- A. 216° B. 108°
 C. 68° D. 54°

43.

x	2	4	6	8
f	4	y	6	5

If the mean of the above frequency distribution is 5.2, find y

- A. 6.0 B. 5.2
 C. 5.0 D. 4.0

44.

No. of children	0	1	2	3	4	5	6
No. of families	7	11	6	7	7	5	3

Find the mode and median respectively of the distribution above

- A. 2,1 B. 1,2
 C. 1,5 D. 5,2

45.

If the scores of 3 students in a test are 5,6 and 7 find the standard deviation of their scores

- A. $\frac{2}{3}$ B. $\frac{3}{2}\sqrt{3}$
 C. $\sqrt{\frac{2}{3}}$ D. $\sqrt{\frac{3}{2}}$

46.

Sample variance can be defined as

$$S^2 = \frac{1}{n} \sum_{i=1}^n (x_i - \bar{x})^2 \text{ and } S^2 = \frac{1}{n-1} \sum_{i=1}^n (x_i - \bar{x})^2$$

Where n is the number of sample observations. There is no difference practically between the above definitions when

- A. $n = 35$ B. $n > 35$
 C. $n < 35$ D. $n = 5$

47.

Two perfect dice are throw together. Determine the probability of obtaining a total score of 8

- A. 1/12 B. 5/36
 C. 1/8 D. 7/36

48.

The probability of an event P is $\frac{3}{4}$ while that of another Q is $\frac{1}{6}$. if the probability of both P and Q is $\frac{1}{12}$, what is the probability of either P or Q?

- A. 1/96 B. 1/8
 C. 5/6 D. 11/12

49.

Five people are to be arranged in a row for a group photograph. How many arrangements are there if a married couple in the group insist on sitting next to each other?

- A. 48 B. 24
 C. 20 D. 10

50.

A student has 5 courses to take from Mathematics and Physics. There are 4 courses in Mathematics and 3 in Physics which he can choose from at will. In how many ways can he choose his courses so that he takes exactly two courses in Physics?

- A. 11 B. 12
 C. 10 D. 7

Mathematics 1993

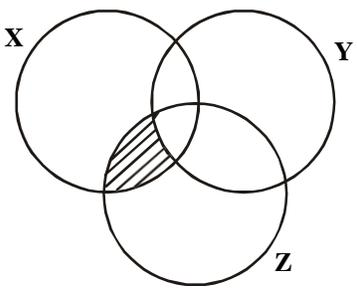
- Change 71_{10} to base 8
 A. 107_8 B. 106_8
 C. 71_8 D. 17_8
- Evaluate $3524/0.05$ correct to 3 significant figures.
 A. 705 B. 70000
 C. 70480 D. 70500
- If $9^{(x-1/2)} = 3^{x^2}$, find the value of x.
 A. $\frac{1}{2}$ B. 1
 C. 2 D. 3
- Solve for y in the equation $10y, X5^{(2y-2)} \times 4^{(y-1)} = 1$
 A. $\frac{3}{4}$ B. $\frac{2}{3}$
 C. 1 D. $\frac{5}{4}$
- Simplify $1/3 - 2 - 1/3 + 2$
 A. 0 B. $\frac{2}{3}$
 C. -4 D. $-\frac{4}{3}$
- If $2 \log_3 y + \log_{x^2} = 4$, then y is
 A. $(4 - \log_3 x^2)/2$ B. $4/\log_3 x^2$
 C. $\frac{2}{x}$ D. $\pm \frac{9}{x}$
- Solve without using tables
 $\log_5 (62.5) - \log_5 (1/2)$
 A. 3 B. 4
 C. 5 D. 8
- If #225.00 yields #27.00 in x years simple interest at the rate of 4% per annum, find x
 A. 3 B. 4
 C. 12 D. 27
- 

The shaded portion in the venn diagram above is
 A. $X \cap Z$ B. $X \cap Y \cap Z$
 C. $X \cap Y \cap Z$ D. $X \cap Y \cap Z$
- If $\sqrt{x^2 + 9} = x + 1$, solve for x
 A. 5 B. 4
 C. 3 D. 1
- Make x the subject of the relation $1 + ax/1 - ax = p/q$
 A. $p+q/a(p-q)$ B. $p-q/a(p+q)$
 C. $p-q/apq$ D. $pq/a(p-q)$

- Which of the following is a factor of $15 + 7x - 2x^2$?
 A. $x-3$ B. $x+3$
 C. $x-5$ D. $x+5$
- Evaluate $(x+1/x+1)^2 - (x-1/x-1)^2$
 A. $4x^2$ B. $(2/x+2)^2$
 C. 4 D. $4(1+x)$
- Solve the following simultaneous equations for x.
 $x^2 + y - 5 = 0$
 $y - 7x + 3 = 0$
 A. -2, 4 B. 2, 4
 C. -1, 8 D. 1, -8
- Solve the following equation
 $(3x-2)(5x-4) = (3x-2)^2$
 A. $\frac{2}{3}, 1$ B. 1
 C. $\frac{2}{3}, 1$ D. $\frac{2}{3}, 4/5$

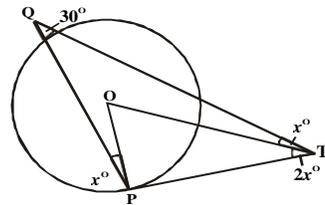

The figure above represents the graphs of $y = x(2-x)$ and $y = (x-1)(x-3)$. What are the x-coordinates of p, q and r respectively?

- A. 1,3,2 B. 0,0,0
 C. 0,2,3 D. 1,2,3
- If the function f is defined by $f(x+2) = 2x^2 + 7x - 5$, find $f(-1)$
 A. -10 B. -8
 C. 4 D. 10
- Divide the expression $x^3 + 7x^2 - x - 7$ by $-1 + x^2$
 A. $-x^3 + 7x^2 - x - 7$ B. $-x^3 - 7x + 7$
 C. $X-7$ D. $X+7$
- Simplify $1/p - 1/q - p/q - q/p$
 A. $1/p - q$ B. $-1/p + q$
 C. $1/pq$ D. $1/pq(p-q)$
- Solve the inequality $y^2 - 3y > 18$
 A. $-2 < y < 6$ B. $y < -3$ or $y > 6$
 C. $y > -3$ or $y > 6$ D. $y < -3$ or $y < 6$
- If x is negative, what is the range of values of x within which $x + 1/3 > 1/x + 3$
 A. $3 < x < 4$ B. $-4 < x < -3$
 C. $-2 < x < -1$ D. $-3 < x < 0$

22. A man's initial salary is #540.00 a month and increases after each period of six months by #36.00 a month. Find his salary in the eighth month of the third year.

- A. #828.00 B. #756.00
C. #720.00 D. #684.00

23. If $k+1, 2k-1, 3k+1$ are three consecutive terms of a geometric progression, find the possible values of the common ratio.

- A. 0, 8 B. -1, 5/3
C. 2, 3 D. 1, -1

24. A binary operation $*$ is defined on a set of real numbers by $x*y = xy$ for all real values of x and y , if $x*2 = x$, find the possible values of x

- A. 0, 1 B. 1, 2
C. 2, 2 D. 0, 2

25.

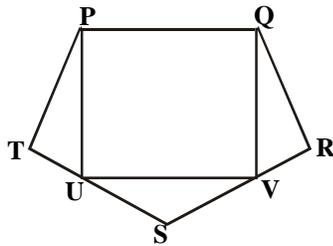

PQRST is a regular pentagon and PQVU is a rectangle with U and V lying on TS and SR respectively as shown in the diagram above. Calculate TUV

- A. 18° B. 54°
C. 90° D. 108°

26. A regular polygon has 150° as the size of each interior angle. How many sides has the polygon?

- A. 12 B. 10
C. 9 D. 8

27. Calculate the length, in cm, of the arc of the circle of diameter 8cm which subtends an angle of $22\frac{1}{2}^\circ$

- A. 2π B. π
C. $\frac{2}{3}\pi$ D. $\frac{\pi}{2}$

28.

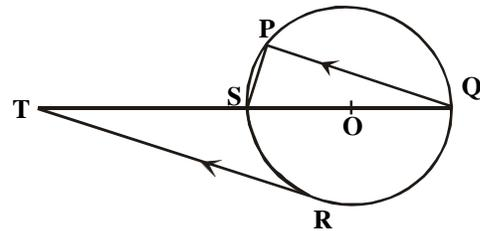

In the diagram above, PQRS is a circle with O as centre and $PQ \perp RT$ if $\angle RTS = 32^\circ$, find $\angle PSQ$

- A. 32° B. 45°
C. 58° D. 90°

29.

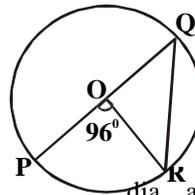

In the diagram above, O is the centre of the circle and PQR is a diameter. If $\angle POR = 96^\circ$, find the value of $\angle ORQ$.

- A. 84° B. 48°
C. 45° D. 42°

30.

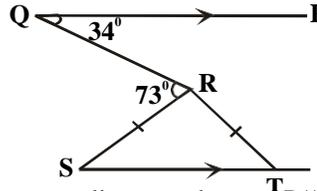

In the diagram above, $QP \parallel ST$; $\angle PQR = 34^\circ$, $\angle QRS = 73^\circ$ and $RS = RT$. Find $\angle SRT$

- A. 68° B. 102°
C. 107° D. 141°

31.

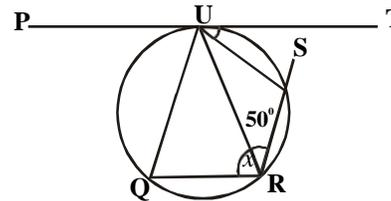

In the figure above, PT is a tangent to the circle at U and $QU \parallel RS$. If $\angle TUR = 35^\circ$ and $\angle SRU = 50^\circ$ find x .

- A. 95° B. 85°
C. 50° D. 35°

32.

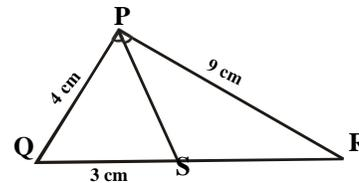

In the diagram above, $\angle QPS = \angle SPR$, $PR = 9\text{cm}$, $PQ = 4\text{cm}$ and $QS = 3\text{cm}$. Find SR.

- A. $\frac{6^3}{4}$ B. $\frac{3^3}{8}$
C. $\frac{4^3}{8}$ D. $\frac{2^2}{3}$

33.

The three sides of an isosceles triangle are of lengths $x+3, 2x+3, 2x-3$ respectively. Calculate x .

- A. 0 B. 1
C. 3 D. 6

34.

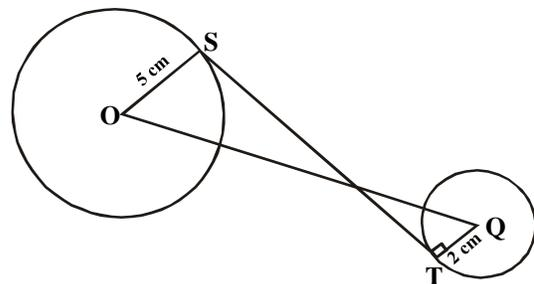

In the figure above, the line segment ST is tangent to the two circles at S and T. O and Q are the centres of the circles with OS = 5cm, QT = 2cm and OQ = 14cm. Find ST.

- A. $7\sqrt{3}$ B. 12cm
C. $8\sqrt{7}$ cm D. 7cm

35.

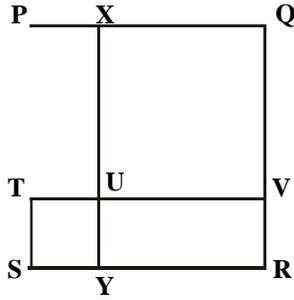

In the figure above, the area of the square PQRS is 100cm^2 . If the ratio of the area of the square TUYS to the area of the square XQVU is 1:16, find YR

- A. 6cm B. 7cm
C. 8cm D. 9cm

36. Find the radius of a sphere whose surface area is 154cm^2 ($\pi=22/7$)

- A. 7.00cm B. 3.50cm
C. 3.00cm D. 1.75cm

37. Find the area of the sector of a circle with radius 3m, if the angle of the sector is 60°

- A. 4.0m^2 B. 4.1m^2
C. 4.7m^2 D. 5.0m^2

38. The angle between latitudes 30°S and 13°N is

- A. 17° B. 33°
C. 43° D. 53°

39. If $\sin \theta = \cos \theta$, find θ between 0° and 360° .

- A. $45^\circ, 225^\circ$ B. $135^\circ, 315^\circ$
C. $45^\circ, 315^\circ$ D. $135^\circ, 225^\circ$

40.

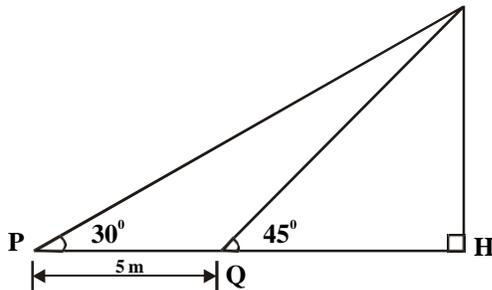

From the figure above, calculate TH in centimeters.

- A. $5/(\sqrt{3}+1)$ B. $5/\sqrt{3}-1$
C. $5/\sqrt{3}$ D. $\sqrt{3}/5$

41. If two angles of a triangle are 30° each and the longest side is 10cm, calculate the length of each of the other sides.

- A. 5cm B. 4cm
C. $3\sqrt{3}$ cm D. $10\sqrt{3}/5$ cm

42.

Quantities in the proportions 1,4,6,7 are to be represented in a pie chart. Calculate the angle of the sector with proportion 7

- A. 20° B. 80°
C. 120° D. 140°

43.

No of students

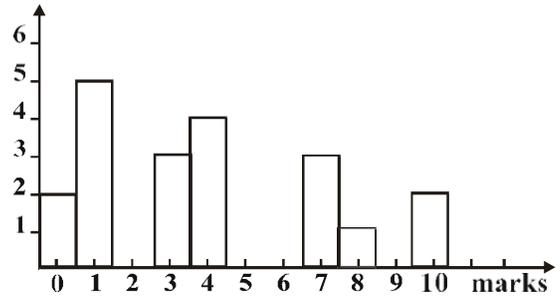

The bar chart above shows the distribution of marks in a class test. How many students took the test?

- A. 15 B. 20
C. 25 D. 50

44.

The following marks were obtained by twenty students in an examination

53 30 70 84 59 43 90 20 78 48
44 60 81 73 50 37 67 68 64 52

Find the number of students who scored at least 50marks

- A. 6 B. 10
C. 13 D. 14

45.

Weight (g)	0-10	10-20	20-30	30-40	40-50
No. of coconuts	10	27	19	6	2

Estimate the mode of the frequency distribution above.

- A. 13.2g B. 15.0g
C. 16.8g D. 17.5g

46.

The mean of the ages of ten secondary school pupils is 16 but when the age of their teacher is added to it, the mean becomes 19. Find the age of the teacher.

- A. 27 B. 35
C. 38 D. 49

47.

Class	Frequency
1 - 5	2
6 - 10	4
11 - 15	5
16 - 20	2
21 - 25	3
26 - 30	2
31 - 35	1
36 - 40	1

Find the median of the observations in the table

- above.
- A. 11.5 B. 12.5
C. 14.0 D. 14.5
48. A number is selected at random between 20 and 30 both numbers inclusive. Find the probability that the number is a prime
A. $\frac{2}{11}$ B. $\frac{5}{11}$
C. $\frac{6}{11}$ D. $\frac{8}{11}$
49. Calculate the standard deviation of the following data.
7, 8, 9, 10, 11, 12, 13.
A. 2 B. 4
C. 10 D. 11
50. The chances of three independent event X, Y, Z occurring are $\frac{1}{2}$, $\frac{2}{3}$, $\frac{1}{4}$ respectively. What are the chances of y and z only occurring?
A. $\frac{1}{8}$ B. $\frac{1}{24}$
C. $\frac{1}{12}$ D. $\frac{1}{4}$

Mathematics 1994

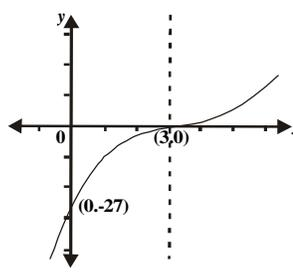
1. Evaluate $\frac{1}{3} \div \left[\frac{5}{7} \left(\frac{9}{10} - 1 + \frac{3}{4} \right) \right]$
A. $\frac{28}{39}$ B. $\frac{13}{84}$
C. $\frac{39}{28}$ D. $\frac{84}{13}$
2. Evaluate $(0.36 \times 5.4 \times 0.63) (4.2 \times 9.0 \times 2.4)$ correct to 2 significant figures
A. 0.013 B. 0.014
C. 0.13 D. 0.14
3. Evaluate $\frac{\text{Log}_3(0.04)}{(\text{Log}_3 18 - \text{Log}_3 2)}$
A. 1 B. -1
C. $\frac{2}{3}$ D. $-\frac{2}{3}$
4. Without using tables, solve the equation $8x^{-2} = \frac{2}{25}$
A. 4 B. 6
C. 8 D. 10
5. Simply $\sqrt{48 - \frac{9}{\sqrt{3}}} + \sqrt{75}$
A. $5\sqrt{3}$ B. $6\sqrt{3}$
C. $8\sqrt{3}$ D. $18\sqrt{3}$
6. Given that $\sqrt{2} = 1.414$, find without using tables, the value of $\frac{1}{\sqrt{2}}$
A. 0.141 B. 0.301
C. 0.667 D. 0.707
7. In a science class of 42 students, each offers at least one of Mathematics and Physics. If 22 students offer Physics and 28 students offer Mathematics, find how many students offer Physics only?
A. 6 B. 8
C. 12 D. 14
8. Given that for sets A and B, in a universal set E, $A \subseteq B$ then $A \cap (A \cap B)'$ is
A. A B. \emptyset
C. B D. Σ
9. Solve for x if $25^x + 3(5^x) = 4$
A. 1 or -4 B. 0
C. 1 D. -4 or 0
10. Simplify $\frac{[(2m - u)^2 - (m - 2u)^2]}{(5m^2 - 5u^2)}$
A. $\frac{3}{4}$ B. $\frac{2}{5}$
C. $2m - u/5m + u$ D. $m - 2u/m + 5u$
11. Factorize $a^2x - b^2y - b^2x + a^2y$
A. $(a - b)(x + y)$ B. $(y - x)(a - b)(a + b)$
C. $(x - y)(a - b)(a + b)$ D. $(x + y)(a - b)(a + b)$
12. Find the values of p and q such that $(x - 1)$ and $(x - 3)$ are factors of $px^3 + qx^2 + 11x - 6$
A. -1, -6 B. 1, -6
C. 1, 6 D. 6, -1
13. 
- The equation of the graph above is
A. $y = (x - 3)^3$ B. $y = (x + 3)^3$
C. $y = x^3 - 27$ D. $y = -x^3 + 27$
14. If $a = 1$, $b = 3$, solve for x in the equation $\frac{a}{a - x} = \frac{b}{x - b}$
A. $\frac{4}{3}$ B. $\frac{2}{3}$
C. $\frac{3}{2}$ D. $\frac{3}{4}$
15. Solve for r in the following equation $\frac{1}{(r - 1)} + \frac{2}{(r + 1)} = \frac{3}{r}$
A. 3 B. 4
C. 5 D. 6
16. Find P if $x - \frac{3}{(1 - x)(x + 2)} = \frac{P}{(1 - x)} + \frac{Q}{(x + 2)}$
A. $-\frac{2}{3}$ B. $-\frac{5}{3}$
C. $\frac{5}{3}$ D. $\frac{2}{3}$
17. Find the range of values of x for which $\frac{1}{x} > 2$ is true
A. $x < \frac{1}{2}$ B. $x < 0$ or $x > \frac{1}{2}$
C. $0 < x < \frac{1}{2}$ D. $1 < x < 2$

18.

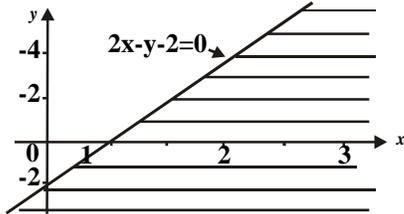

Find the inequality which represents the shaded portion in the diagram

- A. $2x - y - 2 \leq 0$ B. $2x - y - 2 \geq 0$
 C. $2x - y - 2 < 0$ D. $2x - y - 2 > 0$

19. If the 6th term of an arithmetic progression is 11 and the first term is 1, find the common difference.

- A. $\frac{12}{5}$ B. $\frac{5}{3}$
 C. -2 D. 2

20. Find the value of r if $\log_{10} r + \log_{10} r^2 + \log_{10} r^4 + \log_{10} r^8 + \log_{10} r^{16} + \log_{10} r^{32} = 63$

- A. 10^{-8} B. 10^0
 C. 10 D. 10^2

21. Find the nth term of the sequence

3, 6, 10, 15, 21,

- A. $n(n - 1/2)$ B. $n(n + 1/2)$
 C. $(n + 1)(n + 2)/2$ D. $n(2n + 1)$

22. A binary operation * is defined on the set of all positive integers by $a*b = ab$ for all positive integers a, b. which of the following properties does NOT hold?

- A. Closure B. Associativity.
 C. Identity. D. Inverse.

23.

$\otimes \text{ mod } 10$	2	4	6	8
2	4	8	2	6
4	8	6	4	2
6	2	4	6	8
8	6	2	8	4

The multiplication table above has modulo 10 on the set $S = \{2, 4, 6, 8\}$. Find the inverse of 2

- A. 2 B. 4
 C. 6 D. 8

Solve for x and y

$$\begin{vmatrix} 1 & 1 \\ 3 & y \end{vmatrix} \begin{vmatrix} x \\ 1 \end{vmatrix} = \frac{4}{1}$$

24.

- A. $x = -3, y = 3$ B. $x = 8, y = 3$
 C. $x = 3, y = -8$ D. $x = 8, y = -3$

25. The determinant of the matrix

$$\begin{pmatrix} 1 & 2 & 3 \\ 4 & 5 & 6 \\ 2 & 0 & -1 \end{pmatrix} \text{ is}$$

- A. -67 B. -57

26.

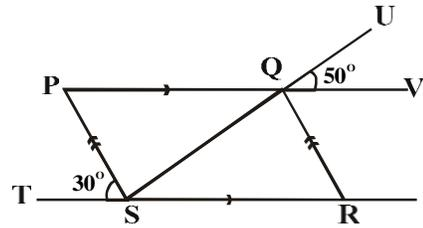

The equation of the line in the graph above is

- A. $3y = 4x + 12$ B. $3y = 3x + 12$
 C. $3y = -4x + 12$ D. $3y = -4x + 9$

27.

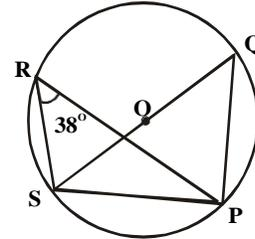

In the diagram above, O is the centre of the circle. If SOQ is a diameter and $\angle PRS = 38^\circ$, what is the value of $\angle PSQ$?

- A. 148° B. 104°
 C. 80° D. 52°

28. If three angles of a quadrilateral are $(3y - x - z)^\circ$, $(2z - 2y - x)^\circ$, find the fourth angle in terms of x, y, and z.

- A. $(360 - x - y - z)^\circ$ B. $(360 + x + y - z)^\circ$
 C. $(180 - x + y + z)^\circ$ D. $(180 + x + y + z)^\circ$

29. An open rectangular box is made of wood 2cm thick. If the internal dimensions of the box are 50cm long, 36cm wide and 20cm deep, the volume of wood in the box is

- A. 11520cm^3 B. 36000cm^3
 C. 38200cm^3 D. 47520cm^3

30. Calculate the perimeter in cm, of a sector of a circle of radius 8cm and angle 45°

- A. 2π B. $8 + 2\pi$
 C. $16 + 2\pi$ D. $16 + 16\pi$

31.3

1
.

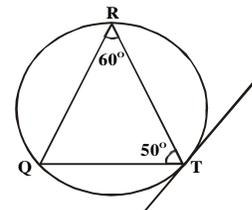

P

In the diagram above, PTS is a tangent to the circle TQR at T. calculate $\angle RTS$.

- A. 120° B. 70°
 C. 60° D. 40°

32.

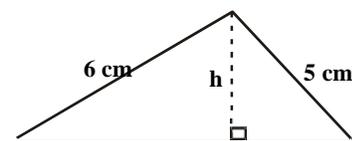

C. -3

D. 3

7 cm

In the diagram above, find h.

- A. $\frac{12}{7}$ cm B. $\frac{12}{2} \sqrt{6}$ cm
 C. $\frac{7}{12}$ cm D. $\frac{1}{2} \sqrt{51}$ cm

33.

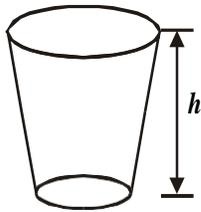

In the frustum of a cone shown above, the top diameter is twice the bottom diameter. If the height of the frustum is h centimeters, find the height of the cone.

- A. 2h B. $2\pi h$
 C. πh D. $\pi h/2$

34.

What is the locus of a point P which moves on one side of a straight line XY, so that the angle XPY is always equal to 90°

- A. The perpendicular bisector of XY
 B. A right-angled triangle.
 C. A circle D. A semi-circle.

35.

If M(4,q) is the mid-point of the line joining L(p, -2) and N(q, p), find the values of p and q.

- A. p = 2, q = 4 B. p = 3, q = 1
 C. p = 5, q = 3 D. p = 6, q = 2

36.

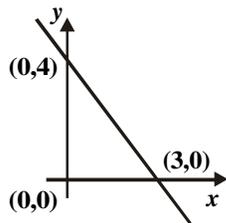

47.

37.

The angle of depression of a boat from the top of a cliff 10m high is 30° . how far is the boat from the foot of the cliff?

- A. $5\sqrt{3}/3$ m B. $5\sqrt{3}$ m
 C. $10\sqrt{3}$ m D. $10\sqrt{3}/3$ m

38.

What is the value of $\sin(-690^\circ)$?

- A. $\sqrt{3}/2$ B. $-\sqrt{3}/2$
 C. $-1/2$ D. $1/2$

39.

If $y = 3t^3 + 2t^2 - 7t + 3$, find $\frac{dy}{dt}$ at $t = -1$

- A. -1 B. 1
 C. -2 D. 2

40.

Find the point (x, y) on the Euclidean plane where the curve $y = 2x^2 - 2x + 3$ has 2 as gradient.

- A. (1,3) B. (2,7)
 C. (0,3) D. (3,15)

41.

Integrate $(1-x)/x^3$ with respect to x.

- A. $(x-x^2)/(x^4+k)$ B. $4/x^4 - 3/x^3 + k$
 C. $1/x - 1/2x^2 + k$ D. $1/3x^3 - 1/2x + k$

42.

Evaluate $\int_{-1}^1 (2x+1)^2 dx$

- A. $3^2/3$ B. 4
 C. $4^1/3$ D. $4^2/3$

43.

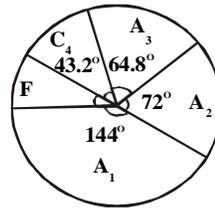

The grades A1, A2, A3, C4 and F earned by students in a particular course are shown in the pie chart above. What percentage of the students obtained a C4 grade?

- A. 52.0 B. 43.2
 C. 40.0 D. 12.0

44.

x	1	2	3	4	5
f	2	1	2	1	2

The table above shows the frequency distribution of a data. If the mean is $43/14$, find y.

- A. 1 B. 2
 C. 3 D. 4

45.

The mean of twelve positive numbers is 3. when another number is added, the mean becomes 5. find the thirteenth number.

- A. 29 B. 26
 C. 25 D. 24

46.

Find the mean deviation of the set of numbers 4, 5, 9

- A. 0 B. 2
 C. 5 D. 6

Class interval	1-5	6-10	11-15	16-20	21-25
Frequency	6	15	20	7	2

Estimate the median of the frequency distribution above.

- A. $10\frac{1}{2}$ B. $11\frac{1}{2}$
 C. $12\frac{1}{2}$ D. 13

48.

x	1	2	3	4	5
f	y + 2	y - 1	2y + 3	y + 4	3y - 4

Find the variance of the frequency distribution above

- A. $3/2$ B. $9/4$
 C. $5/2$ D. 3

49.

Age in years	10	11	12
Number of pupils	6	27	7

The table above shows the number of pupils in each age group in a class. What is the probability that a pupil chosen at random is at least 11 years old?

- A. $27/40$ B. $17/20$
 C. $33/40$ D. $3/20$

50. In a survey, it was observed that 20 students read newspapers and 35 read novels. If 40 of the students read either newspaper or novels, what is the probability of the students who read both newspapers and novel?
- A. $\frac{1}{2}$ B. $\frac{2}{3}$
 C. $\frac{3}{8}$ D. $\frac{3}{11}$

Mathematics 1995

1. Calculate $3310_5 - 1442_5$
 A. 1313_5 B. 2113_5 C. 4302_5 D. 1103_5
2. Convert 3.1415926 to 5 decimal places
 A. 3.14160 B. 3.14159 C. 0.31415 D. 3.14200
3. The length of a notebook 15cm, was measured as 16.8cm. calculate the percentage error to 2 significant figures.
 A. 12.00% B. 11.00% C. 10.71% D. 0.12%
4. A worker's present salary is #24,000 per annum. His annual increment is 10% of his basic salary. What would be his annual salary at the beginning of the third year?
 A. #28,800 B. #29,040 C. #31,200 D. #31,944
5. Express the product of 0.0014 and 0.011 in standard form.
 A. 1.54×10^2 B. 1.54×10^{-3} C. 1.54×10^4 D. 1.54×10^5
6. Evaluate $\frac{81^{3/4} - 27^{1/3}}{3 \times 2^3}$
 A. 27 B. 1 C. 1/3 D. 1/8
7. Find the value of $(16)^{3/2} + \log_{10} 0.0001 + \log_2 32$
 A. 0.065 B. 0.650 C. 6.500 D. 65.00
8. Simplify $\frac{\sqrt{12} - \sqrt{3}}{\sqrt{12} + \sqrt{3}}$
 A. 1/3 B. 0 C. 9/15 D. 1
9. Four members of a school first eleven cricket team are also members of the first fourteen rugby team. How many boys play for at least one of the two teams?
 A. 25 B. 21 C. 16 D. 3
10. If $S = \{x : x^2 = 9, x > 4\}$, then S is equal to
 A. 0 B. {0} C. f D. {f}
11. If $x - 1$ and $x + 1$ are both factors of the equation $x^3 + px^2 + qx + 6 = 0$, evaluate p and q
 A. -6, -1 B. 6, 1 C. -1 D. 6, -6
12. Find a positive value of p if the equation $2x^2 - px + p$ leaves a remainder 6 when added
 A. 1 B. 2 C. 3 D. 4
13. Find r in terms of K, Q and S if $s = 2r\sqrt{(Q\pi T + K)}$
 A. $\frac{r^2}{2\pi r^2 Q} - k$ B. $\frac{r^2}{4\pi r^2 Q} - k$
 C. $\frac{r^2}{2\pi r 2Q} - k$ D. $\frac{r^2}{4\pi r 2Q} - k$
14. The graph of $f(x) = x^2 - 5x + 6$ crosses the x-axis at the points
 A. (-6,0)(-1,0) B. (-3,0)(-2,0)
 C. (-6,0)(1,0) D. (2,0)(3,0)
15. Factorize completely the expression $abx^2 + 6y - 3ax - 2byx$
 A. $(ax - 2y)(bx - 3)$ B. $(bx + 3)(2y - ax)$
 C. $(bx + 3)(ax - 2y)$ D. $(ax - 2y)(ax - b)$
16. Solve the following inequality $(x - 3)(x - 4) \leq 0$
 A. $3 \leq x \leq 4$ B. $3 < x < 4$
 C. $3 \leq x < 4$ D. $3 < x \leq 4$
17. The 4th term of an A.P is 13cm while the 10th term is 31. find the 31st term.
 A. 175 B. 85
 C. 64 D. 45
18. Simplify $\frac{x^2 - 1}{x^3 + 2x^2 - x - 2}$
 A. $\frac{1}{x} + 2$ B. $x - \frac{1}{x} + 1$
 C. $x - \frac{1}{x} + 2$ D. $\frac{1}{x} - 2$
19. Express $5x - \frac{1}{2}(x - 2)(x - 3)$ in partial fraction
 A. $\frac{2}{x} - 2 - \frac{3}{x - 3}$ B. $\frac{2}{x} - 2 + \frac{3}{x - 3}$
 C. $\frac{2}{x} - 3 - \frac{3}{x - 2}$ D. $\frac{5}{x} - 3 + \frac{4}{x - 2}$
20. Use the graph of the curve $y = f(x)$ above to solve the inequality $f(x) > 0$.
 A. $-1 \leq x \leq 1, x > 2$ B. $x \leq -1, 1 < x < 2$
 C. $x \leq -1, 1 \leq x \leq 2$ D. $x \leq 2, -1 \leq x \leq 1$
21. Which of the following binary operation is commutative in a set of integers?
 A. $a * b = a + 2b$ B. $a * b = a + b - ab$
 C. $a * b = a^2 + b$ D. $a * b = a(b + 1)/2$
22. If $a * b = +\sqrt{ab}$, Evaluate $2 * (12 * 27)$
 A. 12 B. 9
 C. 6 D. 2
23. Find the sum to infinity of the following sequence
 $1, 9/10, (9/10)^2, (9/10)^3$
 A. 1/10 B. 9/10
 C. 10/9 D. 10
24. Find the value of K if $\begin{vmatrix} 2 & 1 & 1 \\ 2 & 1 & k \\ 1 & 3 & -1 \end{vmatrix} = 23$
 A. 1 B. 2

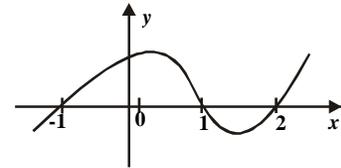

25. If $X = \begin{vmatrix} 1, 2 \\ 0, 3 \end{vmatrix}$ and $Y = \begin{vmatrix} 2, 1 \\ 4, 3 \end{vmatrix}$
- A. (10, 7) B. (2, 7)
 (12, 9) (1, 17)
 C. (10, 4) D. (4, 3)
 (4, 6) (10, 9)

26.

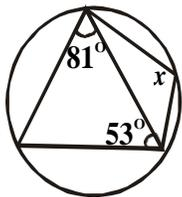

Determine the value of x in the figure above

- A. 134° B. 81°
 C. 53° D. 46°

27.

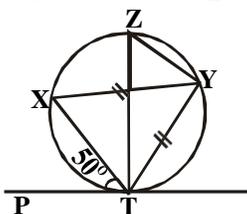

PT is a tangent to the circle TYZX, $YT = YX$ and $\angle PTX = 50^\circ$. calculate $\angle TZY$

- A. 50° B. 65°
 C. 85° D. 130°

28. In a triangle XYZ, $\angle YXZ = 440^\circ$ and $\angle XYZ = 112^\circ$. calculate the acute angle between the internal triangle of $\angle XYZ$ and $\angle XZY$.

- A. 42° B. 56°
 C. 68° D. 78°

29. Find the distance between two towns P($45^\circ N, 30^\circ W$) and Q($15^\circ S, 30^\circ W$) if the radius of the earth is 7 000km.

- A. $\frac{1\ 100}{3}$ B. $\frac{2\ 200}{3}$
 C. $\frac{11\ 000}{3}$

30. Two perpendicular lines PQ and QR intersect at (1, -1). If the equation of PQ is $x - 2y + 4 = 0$, find the equation of QR.

- A. $x - 2y + 1 = 0$ B. $2x + y - 3 = 0$
 C. $x - 2y - 3 = 0$ D. $2x + y - 1 = 0$

31. P is on the locus of a point equidistant form two given points X and Y. UV is a straight line through Y parallel to the locus. If $\angle PYU$ is 40° find $\angle XPY$

- A. 100° B. 80°
 C. 50° D. 40°

32.

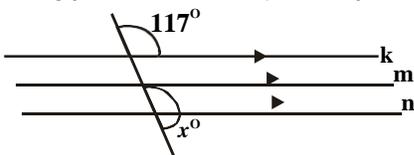

In the diagram above, k, m, and n are parallel lines. What is the value of the angle marked x ?

- A. 37° B. 63°
 C. 117° D. 153°

33.

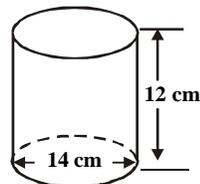

In the diagram above, the base diameters is 14cm while the height is 12cm. Calculate the total surface area if the cylinder has both a base and a top ($p = 22/7$)

- A. 836cm^2 B. 528cm^2
 C. 308cm^2 D. 154cm^2

34.

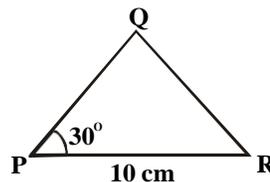

In the diagram above, find PQ if the area of triangle PQR is 35cm^2

- A. 97cm B. 10cm
 C. 14cm D. 17cm

35. A schoolboy lying on the ground 30m away from the foot of a water tank lower observes that the angle of elevation of the top of the tank is 60° . Calculate the height of the water tank.

- A. 60m B. 30.3m
 C. 20.3m D. 10.3m

36. QRS is a triangle with $QS = 12\text{m}$, $\angle RQS = 30^\circ$ and $\angle QRS = 45^\circ$, calculate the length of RS.

- A. $18\sqrt{2}\text{m}$ B. $12\sqrt{2}\text{m}$
 C. $6\sqrt{2}\text{m}$ D. $3\sqrt{2}\text{m}$

37. Which of the following is a sketch of $y = 3 \sin x$?

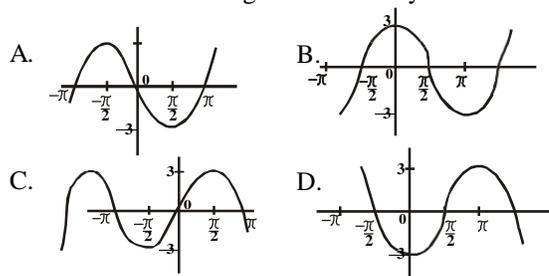

38. The derivative of cosec x is

- A. $\tan x \operatorname{cosec} x$ B. $-\cot x \operatorname{cosec} x$
 C. $\tan x \sec x$ D. $-\cot x \sec x$

39. For what value of x is the tangent o the curve $y = x^2 - 4x + 3$ parallel to the $x - \text{axis}$?

- A. 3 B. 2
 C. 1 D. 0

40. Two variables x and y are such that $dy/dx = 4x - 3$ and $y = 5$ when $x = 2$. find y in terms of x

- A. $2x^2 - 3x + 5$ B. $2x^2 - 3x + 3$ C. $2x^2 - 3x$ D. 4

41. Find the area bounded by the curve $y = 3x^2 - 2x + 1$, the coordinates $x = 1$ and $y = 3$ and the $x - \text{axis}$

- A. 24.9. B. 22 47 C. 21 D. 20

42.

Age in years	13	14	15	16	17
No. of students	3	10	30	42	15

The frequency distribution above shows the ages of students in a secondary school. In a pie chart constructed to represent the data, the angle corresponding to the 15 years-old is
 A. 27° B. 30° C. 54° D. 108°

43.

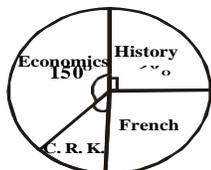

The pie chart above shows the distribution of students in a secondary school class. If 30 students offered French, how many offered C.R.K?
 A. 25 B. 15 C. 10 D. 8

44.

The mean and the range of the set of numbers 0.20, 1.00, 0.90, 1.40, 0.80, 0.80, 1.20, and 1.10 are m and r respectively. Find m + r
 A. 1.11 B. 1.65 C. 1.85 D. 2.45

45.

Class	1 - 3	4 - 6	7 - 9
Frequency	5	8	5

Find the standard deviation of the data using the table above
 A. .5 B. $\sqrt{6}$ C. $5/3$ D. $\sqrt{5}$

46. The variance of the scores 1,2,3,4,5 is
 A. 1.2 B. 1.4 C. 2.0 D. 3.0

Use the table below to answer questions 47 and 48

Class Interval	Frequency	Class Boudaries	Class Mid-poir
1.5-1.9	2	1.45-1.95	1.7
2.0-2.4	1	1.95-2.45	2.2
2.5-2.9	4	2.45-2.95	2.7
3.0-3.4	15	2.95-3.45	3.2
3.5-3.9	10	3.45-3.95	3.7
4.0-4.4	5	3.95-4.45	4.2
4.5-4.9	3	4.45-4.95	4.7

47. find the mode of the distribution
 A. 3.2 B. 3.4 C. 3.7 D. 4.2
48. The median of the distribution is
 A. 4.0 B. 3.5 C. 3.2 D. 3.0
49. Let P be a probability function on set S, where $S = \{a_1, a_2, a_3, a_4\}$ find $P(a_1)$ if $P(a_2) = P(a_3) = 1/6$ and $P(a_4) = 1/5$
 A. $7/10$ B. $2/3$ C. $1/3$ D. $3/10$
50. A die has four of its faces coloured while and the remaining two coloured black. What is the probability that when the die is thrown two consecutive times, the top face will be white in both cases?
 A. $2/3$ B. $1/9$ C. $4/9$ D. $1/36$

Mathematics 1997

1. If $(1PO3)_4 = 115_{10}$, find P
 A. 0 B. 1
 C. 2 D. 3
2. Evaluate $64.764^2 - 35.236^2$ correct to 3 significant figures
 A. 2960 B. 2950
 C. 2860 D. 2850
3. Find the value of $(0.006)^3 + (0.004)^3$ in standard form.
 A. 2.8×10^{-9} B. 2.8×10^{-8}
 C. 2.8×10^{-7} D. 2.8×10^{-6}
4. Given that $\log_a 2 = 0.693$ and $\log_a 3 = 1.097$, find $\log_a 13.5$
 A. 1.404 B. 1.790
 C. 2.598 D. 2.790
5. Simplify $\log_2 96 - 2\log_2 6$
 A. $2 - \log_2 3$ B. $3 - \log_2 3$
 C. $\log_2 3 - 3$ D. $\log_2 3 - 2$
6. If $8^{x/2} = [2^{3/8}][4^{3/4}]$, find x
 A. $3/8$ B. $3/4$
 C. $4/5$ D. $5/4$
7. Simplify $(2\sqrt{3} + 3\sqrt{5}) / (3\sqrt{5} - 2\sqrt{3})$
 A. $19 + 4\sqrt{15}/11$ B. $19 + 4\sqrt{15}/19$
 C. $19 + 2\sqrt{15}/11$ D. $19 + 2\sqrt{15}/19$
8. Find the simple interest rate per cent per annum at which #1000 accumulates to #1240 in 3 years.
 A. 6% B. 8%
 C. 10% D. 12%
9. If $U = \{S, P, L, E, N, D, O, U, R\}$
 $X = \{S, P, E, N, D\}$
 $Y = \{P, N, O, U, R\}$
 Find $X \cap (Y \cup Z)$.
 A. $\{P, O, U, R\}$ B. $\{S, P, D, R\}$
 C. $\{P, N, D\}$ D. $\{N, D, U\}$
10. A survey of 100 students in an institution shows that 80 students speak Hausa and 20 students Igbo, while only 9 students speaks both languages. How many students neither Hausa nor Igbo?
 A. 0 B. 9
 C. 11 D. 20
11. If the function $(x) = x^3 + 2x^2 + qx - 6$ is divisible by $x + 1$, find q.
 A. -5 B. -2
 C. 2 D. 5

12. Solve the simultaneous equations
 $\frac{1}{x} - \frac{3}{y} = 2, \frac{4}{x} + \frac{3}{y} = 10$
 A. $x = \frac{3}{2}, y = \frac{1}{2}$ B. $x = \frac{1}{2}, y = \frac{3}{2}$
 C. $x = -\frac{1}{2}, y = -\frac{3}{2}$ D. $x = \frac{1}{2}, y = -\frac{3}{2}$

13. Find the minimum value of $x^2 - 3x + 2$ for all real values of x .
 A. $-\frac{1}{4}$ B. $-\frac{1}{2}$
 C. $\frac{1}{4}$ D. $\frac{1}{2}$

14. Make f the subject of the formula

$$t = \sqrt{\frac{v}{\left(\frac{1}{f} + \frac{1}{g}\right)}}$$

- A. $gv - t^2/gt^2$ B. $gt^2/gv - t^2$
 C. $v/t^{1/2} - 1/g$ D. $gv/t^2 - g$

15. What value of g will make the expression $4x^2 - 18xy - g$ a perfect square?
 A. 9 B. $9y^2/4$
 C. $81y^2$ D. $81y^2/4$

16. Find the value of K if $\frac{5+2r}{(r+1)(r-2)}$ expressed in partial fraction is $\frac{K}{r-2} + \frac{L}{r+1}$, where K and L are constants.
 A. 3 B. 2
 C. 1 D. -1

17. Let $f(x) = 2x + 4$ and $g(x) = 6x + 7$ where $g(x) > 0$. solve the inequality $\frac{f(x)}{g(x)} < 1$
 A. $x < -\frac{3}{4}$ B. $x > -\frac{4}{3}$
 C. $x > -\frac{3}{4}$ D. $x > -12$

18. Find the range of values of x which satisfies the inequality $12x^2 < x + 1$
 A. $-1/4 < x < 1/3$ B. $1/4 < x < 1/3$
 C. $-1/3 < x < 1/4$ D. $-1/4 < x < -1/3$

19. S_n is the sum of the first n terms of a series given by $S_n = n^2 - 1$. find the n th term.
 A. $4n + 1$ B. $4n - 1$
 C. $2n + 1$ D. $2n - 1$

20. The n th term of a sequence is given by 3^{1-n} . find the sum of the first three terms of the sequence.
 A. $\frac{13}{9}$ B. $\frac{1}{9}$
 C. $\frac{1}{3}$ D. $\frac{1}{9}$

21. Two binary operations $*$ and \ddot{A} are defined as $m*n = mn - n - 1$ and $m\ddot{A}n = mn + n - 2$ for all real numbers m, n . find the values of $3\ddot{A}(4*5)$.
 A. 60 B. 57
 C. 54 D. 42

22. If $xy = x + y - xy$, find x ,
 when $(x*2) + (x*3) = 68$
 A. 24 B. 22
 C. -12 D. -21

23. Determine $x + y$ if

$$\begin{pmatrix} 2 & -3 \\ -1 & 4 \end{pmatrix} \begin{pmatrix} x \\ y \end{pmatrix} = \begin{pmatrix} -1 \\ 8 \end{pmatrix}$$

 A. 3 B. 4
 C. 7 D. 12

24. Find the non-zero positive value of x which satisfies the equation

$$\begin{vmatrix} x & 1 & 0 \\ 1 & x & 1 \\ 0 & 1 & x \end{vmatrix} = 0$$

- A. 2 B. $\sqrt{3}$
 C. $\sqrt{2}$ D. 1

25. Each of the base angles of an isosceles triangle is 58° and all the vertices of the triangle lie on a circle. Determine the angle which the base of the triangle subtends at the centre of the circle.
 A. 128° B. 116°
 C. 64° D. 58°

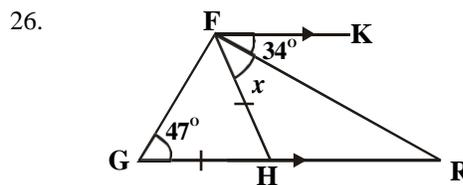

- From the figure above, $FK \parallel GR$ and $FH = GH$, $\angle RFK = 34^\circ$ and $\angle FGH = 47^\circ$. calculate the angle marked x .
 A. 42° B. 52°
 C. 64° D. 72°

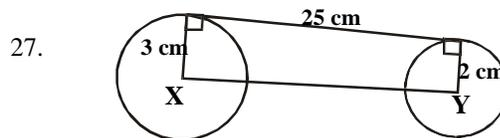

- The figure above shows circles of radii 3cm and 2cm with centres at X and Y respectively. The circles have a transverse common tangent of length 25cm. Calculate XY .
 A. 630 cm B. 626 cm
 C. 615 cm D. 600 cm

28. A chord of a circle diameter 42cm subtends an angle of 60° at the centre of the circle. Find the length of the minor arc.
 A. 22 cm B. 44 cm
 C. 110 cm D. 220 cm
 $[\pi = 22/7]$

29. An arc of a circle subtends an angle of 70° at the centre. If the radius of the circle is 6cm, calculate the area of the sector subtended by the given angle.
 A. 22 cm^2 B. 44 cm^2
 C. 66 cm^2 D. 88 cm^2

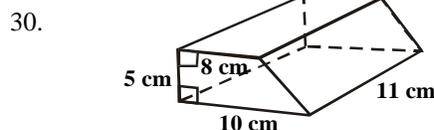

Find the volume of the prism above.

- A. 990cm^3 B. 880cm^3
 C. 550cm^3 D. 495cm^3

31. A cone with the sector angle of 45° is cut out of a circle of radius r cm. find the base radius of the cone.

- A. $r/16\text{cm}$ B. $r/8\text{cm}$
 C. $r/4\text{cm}$ D. $r/2\text{cm}$

32. A point P moves so that it is equidistant from points L and M. if LM is 16cm, find the distance of P from LM when P is 10cm from L.

- A. 12cm B. 10cm
 C. 8cm D. 6cm

33. The angle between the positive horizontal axis and a given line is 135° . find the equation of the line if it passes through the point (2, 3).

- A. $x - y = 1$ B. $x + y = 1$
 C. $x + y = 5$ D. $x - y = 5$

34. Find the distance between the point Q(4, 3) and the point common to the lines $2x - y = 4$ and $x + y = 2$

- A. $3\sqrt{10}$ B. $\sqrt{5}$
 C. $\sqrt{26}$ D. $\sqrt{13}$

35. The angle of elevation of a building from a measuring instrument placed on the ground is 30° . if the building is 40m high, how far is the instrument from the foot of the building?

- A. $20\sqrt{3}\text{m}$ B. $40\sqrt{3}\text{m}$
 C. $20\sqrt{3}\text{m}$ D. $40\sqrt{3}\text{m}$

36. In a triangle XYZ, if $\angle XYZ$ is 60° , $XY = 3\text{cm}$ and $YZ = 4\text{cm}$, calculate the length of the side XZ.

- A. $2\sqrt{3}\text{cm}$ B. 13cm
 C. $2\sqrt{5}\text{cm}$ D. $2\sqrt{3}\text{cm}$

37. X

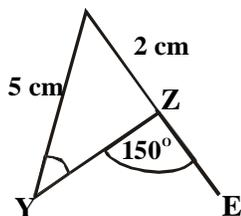

In the figure above, XYZ is a triangle with $XY = 5\text{cm}$, $XZ = 2\text{cm}$ and XZ is produced to E making the angle $YZE = 150^\circ$. if the angle $XYZ = \theta$, calculate the value of the $\sin \theta$.

- A. $3/5$ B. $1/2$
 C. $2/5$ D. $1/5$

38. Differentiate $\frac{6x^3 - 5x^2 + 1}{3x^2}$

- A. $2 + 2/3x^3$ B. $2 + 1/6x$
 C. $2 - 2/3x^3$ D. $2 - 1/6x$

39. $d/dx \cos(3x^2 - 2x)$ is equal to

- A. $-\sin(6x - 2)$ B. $-\sin(3x^2 - 2x)$
 C. $(6x - 2)\sin(3x^2 - 2x)$ D. $(6x - 2)\sin(3x^2 - 2x)$

40. Find the gradient of the curve $y = 2\sqrt{x} - 1/x$ at the point $x = 1$

- A. 0 B. 1 C. 2 D. 3

41. Integrate $1/x + \cos x$ with respect to x .

- A. $-1/x^2 + \sin x + k$ B. $\ln x + \sin x + k$
 C. $\ln x - \sin x + k$ D. $-1/x^2 - \sin x + k$

42. If $y = x(x^4 + x^2 + 1)$, evaluate $\int_{-1}^1 dyx$

- A. $11/12$ B. $11/16$
 C. $5/6$ E. 0

43.

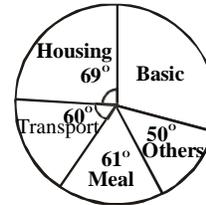

The pie chart above shows the income of a civil servant in a month. If his monthly income is #6000, find his monthly basic salary.

- A. #2000 B. #2600
 C. #3100 D. #3450

44.

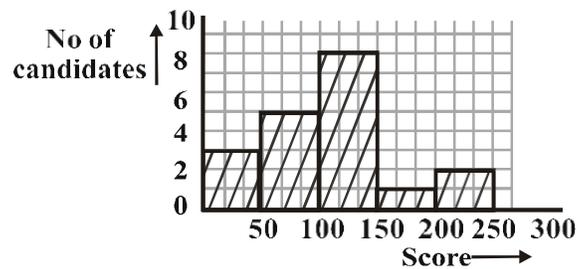

In an examination, the result of a certain school is as shown in the histogram above. How many candidates did the school present?

- A. 12 B. 16
 C. 18 D. 19

45.

Age	20	25	30	35	40	45
No. of students	3	5	1	1	2	3

Find the median age of the frequency distribution in the table above

- A. 20 B. 25
 C. 30 D. 35

46. The following are the scores of ten students in a test of 20 marks; 15,16,17,13,16,8,5,16,19,17. what is the modal score?

- A. 13 B. 15
 C. 16 D. 19

47. Find the standard deviation of the following data - 5,-4,-3,-2,-1,0,1,2,3,4,5

- A. 2 B. 3
 C. $\sqrt{10}$ D. $\sqrt{11}$

48. Find the difference between the range and the variance of the following set of numbers 4,9,6,3,2,8,10,5,6,7 where $d^2 = 60$.

- A. 2 B. 3
 C. 4 D. 6

49. In a basket of fruits, there are 6 grapes, 11 bananas and 13 oranges. If one fruit is chosen at random, what is the probability that the fruit is either a grape or a banana?
 A. $17/30$ B. $11/30$
 C. $6/30$ D. $5/30$
50. A number is selected at random between 10 and 20, both numbers inclusive. Find the probability that the numbers is an even number.
 A. $5/11$ B. $1/2$
 C. $6/11$ D. $7/10$

Mathematics 1998

1. If $1011_2 + X_7 = 25_{10}$, solve for X
 A. 14 B. 20
 C. 24 D. 25
2. Evaluate $[1/0.03 \div 1/0.024]^{-1}$, correct to 2 decimal places
 A. 3.76 B. 1.25
 C. 0.94 D. 0.75
3. If $b^3 = a^{-3}$ and $c^{1/3} = a^{1/2}b$, express in terms of
 A. $a^{-1/2}$ B. $a^{1/2}$
 C. $a^{3/2}$ D. $a^{-2/3}$
4. Given that $\text{Log}_4(y - 1) + \text{Log}_4(1/2x) = 1$ and $\text{Log}_2(y + 1) + \log_2 x = 2$, solve for x and y respectively
 A. 2, 3 B. 3, 2
 C. -2, -3 D. -3, -2
5. Find the value of K if $K''3 + ''2 = ''3 - 2$
 A. 3 B. 2
 C. ''3 D. ''2
6. A market woman sells oils in cylindrical tins 10cm deep and 6cm diameter at #15.00 each. If she bought a full cylindrical jug 18cm deep and 10cm in diameter for #50.00, how much did she make by selling all the oil?
 A. #62.50 B. #35.00
 C. #31.00 D. #25.00
7. A man is paid r naira per hour for normal work and double rate for overtime. If he does a 35-hour week which includes q hours of overtime, what is his weekly earning in naira?
 A. $r(35 + q)$ B. $q(35r - q)$
 C. $q(35r + r)$ D. $r(35r - q)$
8. Given the universal set $U = \{1,2,3,4,5,6\}$ and the sets $P = \{1,2,3,4\}$, $Q = \{3,4,5\}$ and $R = \{2,4,6\}$. Find $P \cap (Q \cap R)$.
 A. {4} B. {1,2,3,4}
 C. {1,2,3,5,6} D. {1,2,3,4,5,6}

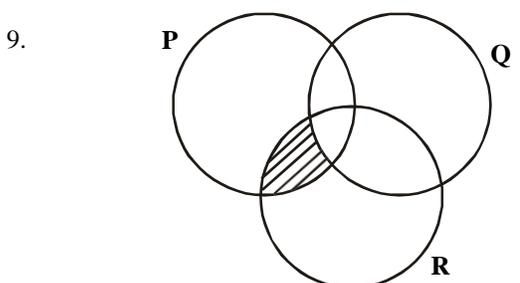

In the venn diagram above, the shaded region is
 A. $(P \cap Q) \cap R$ B. $(P \cap Q) \cap R$
 C. $(P \cap Q) \cap R$ D. $(P \cap Q) \cap R$

10. When the expression $pm^2 + qm + 1$ is divided by $(m - 1)$, it has a remainder 2 and when divided by $(m + 1)$ the remainder is 4. find p and q respectively
 A. 2, -1 B. -1, 2
 C. 3, -2 D. -2, 3
11. Factorize $r^2 - r(2p + q) + 2pq$
 A. $(r - 2q)(2r - p)$ B. $(r - q)(r + p)$
 C. $(r - q)(r - 2p)$ D. $(2r - q)(r + p)$
12. Solve the equation $x\sqrt{x} - (x\sqrt{2}) - 1 = 0$
 A. $3/2$ B. $2/3$
 C. $4/9$ D. $9/4$
13. Find the range of values of m for which the roots of the equation $3x^2 - 3mx + (m^2 - m - 3) = 0$
 A. $-1 < m < 7$ B. $-2 < m < 6$
 C. $-3 < m < 9$ D. $-4 < m < 8$
14. Make a/x the subject of the formula
 $x + a/x - a = m$
 A. $m - 1/m + 1$ B. $1 + m/1 - m$
 C. $1 - m/1 + m$ D. $m + 1/m - 1$
15. Divide $2x^3 + 11x^2 + 17x + 6$ by $2x + 1$
 A. $x^2 + 5x + 6$ B. $2x^2 + 5x + 6$
 C. $2x^2 - 5x + 6$ D. $x^2 - 5x + 6$
16. Express in partial fractions
 $\frac{11x + 2}{6x^2 - x - 1}$
 A. $1/3x - 1 + 3/2x + 1$ B. $3/3x + 1 - 1/2x - 1$
 C. $3/3x - 1 - 1/2x + 1$ D. $1/3x + 1 + 3/2x - 1$
17. If x is a positive real number, find the range of values for which
 $1/3x + 1/2 > 1/4x$
 A. $x > -1/6$ B. $x > 0$
 C. $0 < x < 4$ D. $0 < x < 1/6$

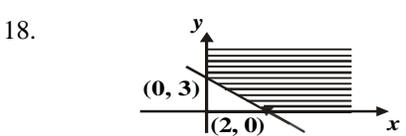

The shaded area above represents
 A. $x \geq 0, 3y + 2x \geq 6$ B. $x \geq 0, y \geq 3, 3x + 2y \geq 6$
 C. $x \geq 2, y \geq 0, 3x + 2y \leq 6$ D. $x \geq 0, y \geq 0, 3x + 2y \geq 6$

19. If $p + 1, 2p - 10, 1 - 4p^2$ are the consecutive terms of an arithmetic progression, find the possible values of p .
- A. -4, 2 B. -2, 4/11
C. -11/4, 2 D. 5, -3

20. The sum of the first three terms of a geometric progression is half its sum to infinity. Find the positive common ratio of the progression.
- A. $\frac{1}{4}$ B. $\frac{1}{2}$
C. $\frac{1}{3} \sqrt{3}$ D. $\frac{1}{3} \sqrt{2}$

21.

\otimes	p	q	r	s
P	r	p	r	p
q	p	q	r	s
r	r	r	r	r
s	q	s	r	q

The identity element with respect to the multiplication shown in the table above is

- A. p B. q
C. r D. s
22. The binary operation $*$ is defined by $x*y = xy - y - x$ for all real values x and y . $x*3 = 2*x$, find x .
- A. -1 B. 0
C. 1 D. 5

23. The determinant of matrix $\begin{vmatrix} x, & 1, & 0 \\ 1-x, & 2, & 3 \\ 1, & 1+x, & 4 \end{vmatrix}$ in terms of x is
- A. $-3x^2 - 17$ B. $-3x^2 + 9x - 1$
C. $3x^2 + 17$ D. $3x^2 - 9x + 5$

24. Let $I = \begin{vmatrix} 1 & 0 \\ 0 & 1 \end{vmatrix}$, $P = \begin{vmatrix} 2 & 3 \\ 4 & 5 \end{vmatrix}$, $Q = \begin{vmatrix} u, & 4+u \\ -2v, & v \end{vmatrix}$ be 2×2 matrices such that $PQ=I$. find (u,v)
- A. $(-5/2, -1)$ B. $(-5/2, 3/2)$
C. $(-5/6, 1)$ D. $(5/2, 2/3)$

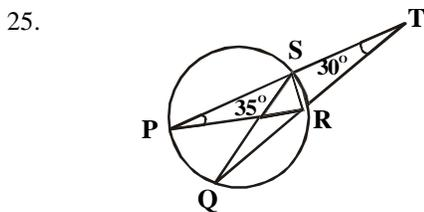

- In the diagram above, PR is a diameter of the circle PQRS. PST and QRT are straight lined. Find $\angle QSR$.
- A. 20°
B. 25°
C. 30°
D. 35°

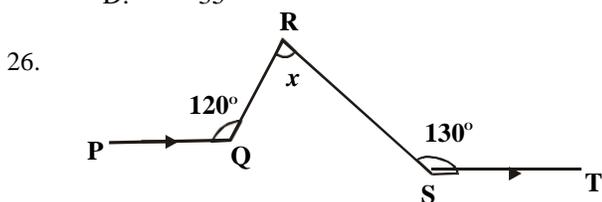

- In the diagram above, $PQ \parallel ST$ and $\angle PQR = 120^\circ$, $\angle RST = 130^\circ$. find the angle marked x .
- A. 50° B. 65°
C. 70° D. 80°

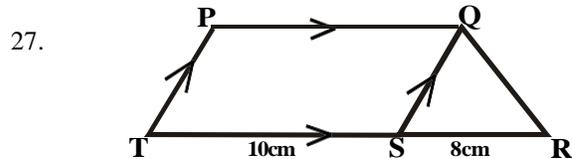

- In the figure above, PQST is a parallelogram and TSR is a straight line. If the area of $\angle QRS$ is 20cm^2 , find the area of the trapezium PQRT.
- A. 35cm^2 B. 65cm^2
C. 70cm^2 D. 140cm^2

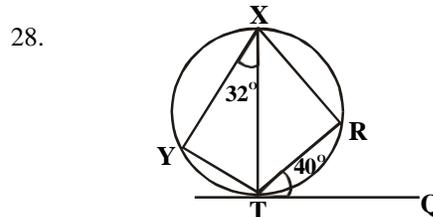

- TQ is tangent to circle XYTR. $\angle YXT = 32^\circ$, $\angle RTQ = 40^\circ$. find $\angle YTR$.
- A. 108° B. 121°
C. 140° D. 148°

29. A chord of a circle radius 3cm subtends an angle of 60° on the circumference of the circle. Find the length of the chord.
- A. $\sqrt{3}/2 \text{ cm}$ B. $3/2 \text{ cm}$
C. $\sqrt{3} \text{ cm}$ D. 3 cm

30. A cylindrical drum of diameter 56 cm contains 123.2 litres of oil when full. Find the height of the drum in centimeters.
- A. 12.5 B. 25.0
C. 45.0 D. 50.0

31. The locus of all points at a distance 8 cm from a point N passes through point T and S. if S is equidistant from T and N, find the area of triangle STN.
- A. $4\sqrt{3} \text{ cm}^2$ B. $16\sqrt{3} \text{ cm}^2$
C. 32cm^2 D. 64 cm^2

32. If the distance between the points $(x, 3)$ and $(-x, 2)$ is 5. find x
- A. 6.0 B. 2.5
C. $\sqrt{6}$ D. $\sqrt{3}$

33. The midpoint of the segment of the line $y = 4x + 3$ which lies between the x -axis and the y -axis is
- A. $(-3/2, 3/2)$ B. $(-2/3, 3/2)$
C. $(3/8, 3/2)$ D. $(-3/8, 3/2)$

34. Solve the equation $\cos x + \sin x = 1/\cos x - \sin x$ for values of x such that $0 \leq x < 2\pi$
- A. $\pi/2, 3\pi/2$ B. $\pi/3, 2\pi/3$
C. $0, \pi/3$ D. $0, \pi$

Mathematics 1999

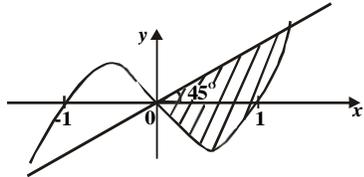
- If $(a^2b^3c)/a^{-1}b^4c^5$
What is the value of $P + 2Q$?
A. $5/2$ B. $-5/4$
C. $-25/4$ D. -10
- Find the value of x if $\sqrt{2}/(x + \sqrt{2}) = 1/(x - \sqrt{2})$
A. $3\sqrt{2} + 4$ B. $3\sqrt{2} - 4$
C. $3 - 2\sqrt{2}$ D. $4 + 2\sqrt{2}$
- A trader bought 100 oranges at 5 for #1.20, 20 oranges got spoiled and the remaining were sold at 4 for #1.50. find the percentage gain or loss
A. 30% gain B. 25% gain
C. 30% loss D. 25% loss
- If $U = \{1, 2, 3, 4, 5, 6\}$, $P = \{3, 4, 5\}$, $Q = \{2, 4, 6\}$ and $R = \{1, 2, 3, 4\}$, list elements of $(P \cap Q) \cap R$.
A. $\{1, 2, 3, 4, 5, 6\}$ B. $\{1, 2, 3, 4\}$
C. $\{1\}$ D. \emptyset
- Divide 2434_6 by 42_6
A. 23_6 B. 35_6
C. 52_6 D. 55_6
- If $2_9x (Y_3) = 3 (Y_3)$, find the value of Y
A. 4 B. 3
C. 2 D. 1
- Simplify $\sqrt{(0.0023 \times 750)/(0.00345)} \times 1.25$
A. 15 B. 20
C. 40 D. 75
- If $\log_8 10 = x$, evaluate $\log_8 5$ in terms of x .
A. $\frac{1}{2}x$ B. $x - \frac{1}{4}$
C. $x - \frac{1}{3}$ D. $x - \frac{1}{2}$
- A group of market women sell at least one of yam, plantain and maize. 12 of them sell maize, 10 sell yam and 14 sell plantain. 5 sell plantain and maize, 4 sell yam and maize, 2 sell yam and plantain only while 3 sell all the three items. How many women are in the group?
A. 25 B. 19
C. 18 D. 17
- Given that $Q = (6, 0)$ and $Q + P = (7, 2)$
 $(4, 5)$ $(6, 8)$
evaluate $|Q + 2P|$
A. 90 B. 96
C. 102 D. 120
- A binary operation $*$ is defined by $a*b = ab + b$ for any real number a and b . if the identity element is zero, find the inverse of 2 under this operation
A. $2/3$ B. $\frac{1}{2}$
C. $-1/2$ D. $56/9$
- The first term of a geometrical progression is twice its common ratio. Find the sum of the first two terms of the progression if its sum to infinity is 8
A. $8/5$ B. $8/3$
C. $72/25$ D. $56/9$
- Tope bought x oranges at #5.00 each and some mangoes at #4.00 each. If she bought twice as many mangoes as oranges and spent at least # and at most #, find the range of the value of x
A. $4 \leq x \leq 5$ B. $5 \leq x \leq 8$
C. $5 \leq x \leq 10$ D. $8 \leq x \leq 10$
- If $m^n = m/n - n/m$, for $m, n \in \mathbb{R}$, evaluate -3^*4
A. $-25/12$ B. $-7/12$
C. $7/12$ D. $25/12$
- Find the matrix T if $ST = I$ where $S = \begin{pmatrix} -1 & 1 \\ 1 & -2 \end{pmatrix}$ and I is the identity matrix.
A. $\begin{pmatrix} -2 & 1 \\ -1 & 1 \end{pmatrix}$ B. $\begin{pmatrix} -2 & -1 \\ -1 & -1 \end{pmatrix}$
C. $\begin{pmatrix} -1 & -1 \\ 0 & -1 \end{pmatrix}$ D. $\begin{pmatrix} -1 & -1 \\ 0 & 1 \end{pmatrix}$
- Divide $4x^3 - 3x + 1$ by $2x - 1$
A. $2x^2 - x + 1$ B. $2x^2 - x - 1$
C. $2x^2 + x + 1$ D. $2x^2 + x - 1$
- Three consecutive positive integers k, l and m are such that $l^2 = 3(k + m)$. find the value of m .
A. 4 B. 5
C. 6 D. 7
- 
The shaded portion in the graph above is represented by
A. $y + x - x^3 \geq 0, y - x \leq 0$ B. $y - x + x^3 \geq 0, y - x \leq 0$
C. $y + x - x^3 \leq 0, y + x^3 \geq 0$ D. $y - x + x^3 \leq 0, y + x \leq 0$
- Factorize completely
 $x^2 + 2xy + y^2 + 3x + 3y - 18$
A. $(x + y + 6)(x + y - 3)$ B. $(x - y - 6)(x - y + 3)$
C. $(x - y + 6)(x - y - 3)$
- The sum of two members is twice their difference. If the difference of the numbers is P , find the larger of the two numbers.
A. $p/2$ B. $3p/2$
C. $5p/2$ D. $3p$
- Express $1/x^3 - 1$
A. B. C. D.

22. In $\triangle MNO$, $MN = 6$ units, $MO = 4$ units and $NO = 12$ units. If the bisector of angle M meets NO at P , calculate NP .
- A. 4.8 units B. 7.2 units
C. 8.0 units D. 18.0 units

23. Find the equation of the locus of a point $P(x, y)$ such that $PV = PW$, where $V = (1, 1)$ and $W = (3, 5)$
- A. $2x + 2y = 9$ B. $2x + 3y = 8$
C. $2x + y = 9$ D. $x + 2y = 8$

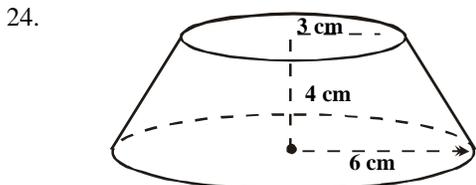

- Find the value of l in the frustum above.
- A. 5cm B. 6cm
C. 7cm D. 8cm

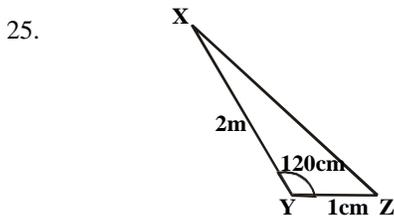

- Find the length XZ in the triangle above
- A. $\sqrt{7}m$ B. $\sqrt{6}m$
C. $\sqrt{5}m$ D. $\sqrt{3}m$

26. Find a positive value of a if the coordinate of the centre of a circle $x^2 + y^2 - 2ax + 4y - a = 0$ is $(a, -2)$ and the radius is 4 units
- A. 1 B. 2
C. 3 D. 4

27. A man 1.7m tall observes a bird on top of a tree at an angle of 30° . if the distance between the man's head and the bird is 25m, what is the height of the tree?
- A. 26.7m B. 14.2m
C. $(1.7 + 25\sqrt{3})/3$ D. $(1.7 + 25\sqrt{2})/2$

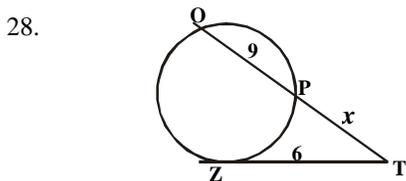

- In the figure above, TZ is tangent to the circle QPZ . Find x if $TZ = 6$ units and $PQ = 9$ units.
- A. 3 B. 4
C. 5 D. 6

29. Find the tangent of the acute angle between the lines $2x + y = 3$ and $3x - 2y = 5$
- A. $-7/4$ B. $7/8$
C. $7/4$ D. $7/2$

30. From the Point P , the bearings of two points Q and R are $N67^\circ W$ and $N23^\circ E$ respectively. If the bearing of R from Q is $N68^\circ E$ and $PQ = 150m$, calculate PR .
- A. 120m B. 140m
C. 150m D. 160m

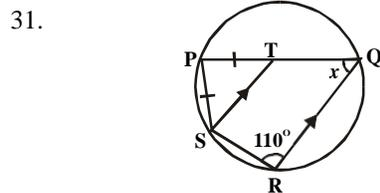

- In the figure above, $PQRS$ is a circle with $ST \parallel RQ$. Find the value of x if $PT = PS$
- A. 70° B. 55°
C. 40° D. 35°

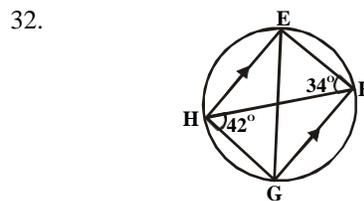

- In the diagrams above, $EFGH$ is a cyclic quadrilateral in which $EH \parallel FG$ and FH are chords. If $\angle FGH = 42^\circ$ and $\angle EFH = 34^\circ$, calculate $\angle HEG$
- A. 34° B. 42°
C. 52° D. 76°

33. If the maximum value of $y = 1 + hx - 3x^2$ is 13, find h .
- A. 13 B. 12
C. 11 D. 10

34. Evaluate $\int_{-2}^1 (x - 1)^2$
- A. $-3^{1/3}$ B. 7
C. 9 D. 11

35. Evaluate $\int_{\pi/4}^{\pi/2} (x - 1)^2 dx$
- A. $\sqrt{2} + 1$ B. $\sqrt{2} - 1$
C. $-\sqrt{2} - 1$ D. $1 - \sqrt{2}$

36. Find the area bounded by the curve $y = x(2 - x)$, the x -axis, $x = 0$ and $x = 2$
- A. 4 sq units B. 2sq units
C. $1\frac{1}{2}$ sq units D. $1/3$ sq units

37. If $y = 3x^2(x^3 + 1)^{1/2}$ find dy/dx
- A. $6x(x^3 + 1) + 3x^2/2(x^3 + 1)^{1/2}$ B. $12x(x^3 + 1) + 3x^2/2(x^3 + 1)^{1/2}$
C. $(15x^4 + 6x)/6x^2(x^3 + 1)^{1/2}$ D. $12x(x^3 + 1) + 9x^4/2(x^3 + 1)^{1/2}$

38. Find the volume of solid generated when the area enclosed by $y = 0$, $y = 2x$ and 3 is rotated about the x -axis.
- A. 81π cubic units B. 36π cubic units
C. 18π cubic units D. 9π cubic units

39. What is the derivative of $t^2 \sin(3t - 5)$ with respects to the variable?
 A. $6t \cos(3t - 5)$ B. $2t \sin(3t - 5) - 3t^2 \cos(3t - 5)$
 C. $2t \sin(3t - 5) + 3t^2 \cos(3t - 5)$
 D. $2t \sin(3t - 5) + t^2 \cos 3t$
40. Find the value of x for which the function $y = x^3 - x$ has a minimum value.
 A. $-\sqrt{3}$ B. $-\sqrt{3}/2$
 C. $\sqrt{3}/3$ D. $\sqrt{3}$
41. Three boys play a game a luck in which their respective chances of wining are $\frac{1}{2}$, $\frac{1}{3}$ and $\frac{1}{4}$. What is the probability that one and only of the boys wins the game?
 A. $\frac{1}{24}$ B. $\frac{1}{12}$
 C. $\frac{11}{24}$ D. $\frac{23}{24}$
42. A number is selected at random from 0 to 20. what is the probability that the number is an odd prime?
 A. $\frac{8}{21}$ B. $\frac{1}{3}$
 C. $\frac{2}{7}$ D. $\frac{5}{21}$
43. If ${}^6C_r / {}^6P_r = 1/6$, find the value of r .
 A. 1 B. 3
 C. 5 D. 6
44. If the standard deviation of the set of numbers 3, 6, x , 7, 5, is $\sqrt{2}$, find the least possible value of x .
 A. 2 B. 3
 C. 4 D. 6
45. How many two digit numbers can be formed from the digits 0, 1, 2, if a digit can be repeated and no number may begin with 0
 A. 4 B. 12
 C. 16 D. 20

The grades of 36 students in a class test are as shown in the pie chart above. How many students had excellent?

- A. 7 B. 8
 C. 9 D. 12

No of students	2	2	11	10	16	51	40	10	25	15	20
Marks	0	1	2	3	4	5	6	7	8	9	10

47.

The marks scored by students in a test are given in the above. Find the median.

- A. 7 B. 6
 C. 5 D. 4

48.

A student calculated the mean of 5 numbers as 45, 3, while rechecking his working, he discovered that his total was short by 20.5. what is the correct mean of the 5 numbers?

- A. 24.8 B. 41.2
 C. 49.4 D. 65.8

49.

The sectorial allocations to various ministries in a state budget are as follows:

- Agriculture - #25 000 000.00
 Education - #20 000 000 .00
 Women affairs - #35 000 000.00
 Commerce and Industries - #20 000 000.00

In a pie chart to represent this information the corresponding angle to agriculture is

- A. 25^0 B. 45^0
 C. 50^0 D. 90^0

50.

The mean of four numbers is 5 and the mean deviation is 3. find the fourth number if the mean deviation of the first three numbers is 2.

- A. 6 B. 10
 C. 11 D. 17

46.

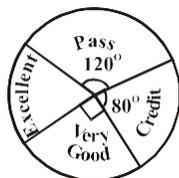

Mathematics 2000

1. Let $P = \{1, 2, u, v, w, x\}$
 $R = \{2, 3, u, v, w, 5, 6, y\}$
 and $R = (2, 3, 4, v, x, y)$
- Determine $(P - Q) \cap R$.
 A. $\{1, x\}$ B. $\{x, y\}$
 C. $\{x\}$ D. ϕ
2. If the population of a town was 240000 in January 1998 and it increased by 2% each year, what would be the population of the town in January 2000?
 A. 480 000 B. 249 696
 C. 249 600 D. 244 800
3. If $2\sqrt{3} - \sqrt{2}/\sqrt{3} + 2\sqrt{2} = m + n\sqrt{6}$,
 Find the values of m and n respectively
 A. 1, -2 B. -2, 1

- C. $-2/5, 1$ D. $2, 3/5$

4.

In a youth club with 94 members, 60 like modern music and 50 like like traditional music. The number of members who like both traditional and modern music is three times who do not like any type of music. How many members like only one type of music?

- A. 8 B. 24
 C. 62 D. 86

5.

Evaluate $\frac{(2.813 \times 10^{-3}) \times 1.063}{5.637 \times 10^{-2}}$

reducing each number to two significant figures and leaving your answers in two significant figures.

- A. 0.056 B. 0.055
 C. 0.054 D. 0.54

6. A man wishes to keep some money in a savings deposit at 25% compound interest so that after 3 years he can buy a car for #150,000. how much does he need to deposit now?

- A. #112,000.50 B. #96,000.00
C. #85,714.28 D. #76,800.00

7. If $314_{10} - 256_7 = 340_x$, find x

- A. 2^{n+1} B. 2^{n-1}
C. 4 D. $\frac{1}{4}$

8. Audu bought an article for #50 000 and sold it to Femi at a loss of x%. Femi later sold the article to Oche at a profit of 40%. If Femi made a profit of #10,000, find the value of x.

- A. 60 B. 50
C. 40 D. 20

9. Simplify $3^{(2n+1)} - 4^{(2n-1)}/2^{(n+1)} - 2^n$

- A. 2^{n+1} B. 2^{n-1}
C. 4 D. $\frac{1}{4}$

10. If $P344_6 - 23P2_6 = 2PP2_6$, find the value of digit P.

- A. 2 B. 3
C. 4 D. 5

11. Evaluate $5^{-3\log_5 2} \times 2^{2\log_2 3}$

- A. 8 B. $1\frac{1}{8}$
C. $\frac{2}{5}$ D. $\frac{1}{8}$

12. A binary operation * is defined by $a * b = a^b$. if $a * 2 = 2 - a$, find the possible values of a.

- A. 1, -1 B. 1, 2
C. 2, -2 D. 1, -2

13. The 3rd term of an A. P. is $4x - 2y$ and the 9th term is $10x - 8y$. find the common difference.

- A. $19x - 17y$ B. $8x - 4y$
C. $x - y$ D. $2x$

14. Find the inverse of p under the binary operation * by $p * q = p + q - pq$, where p and q are real numbers and zero is the identity.

- A. p B. $p - 1$
C. $p/p - 1$ D. $p/p + 1$

15. A matrix $P = \begin{pmatrix} (a, b) \\ (a, b) \\ (c, d) \end{pmatrix}$ is such that $P^T = p$, where

P^T is the transpose of P, if $b = 1$, then P is

- A. (0, 1) B. (0, 1)
C. (1, 0) D. (-1, 0)
C. (0, 1) D. (1, 1)
C. (1, 1) D. (-1, 0)

16. Evaluate $(\frac{1}{2} - \frac{1}{4} + \frac{1}{8} - \frac{1}{16} + \dots)$ -1

- A. $\frac{2}{3}$ B. 0
C. $-\frac{2}{3}$ D. 1

17. The solution of the simultaneous inequalities $2x - 2 \leq y$ and $2y \leq 2x$ is represent by

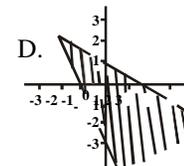
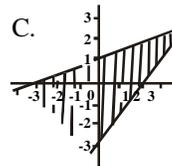
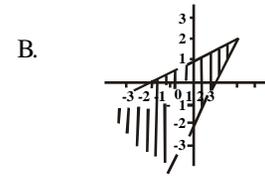
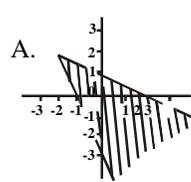

18. Find the values of t for which the determinant of the matrix $\begin{pmatrix} t-4 & 0 & 0 \\ -1 & t+t & 1 \\ 3 & 4 & t-2 \end{pmatrix}$ is zero

- A. 0, 2, 3 B. -4, 2, 3
C. -4, -2, -3 D. 4, -2, 3

19. If $(x - 1)$, $(x + 1)$ and $(x - 2)$ are factors of the polynomial $ax^3 + bx^2 + cx - 1$, find a, b, c, respectively

- A. $-1/2, 1, 1/2$ B. $1/2, 1, 1/2$
C. $1/2, 1, -1/2$ D. $1/2, -1, 1/2$

20. A trader realizes $10x - x^2$ naira profit from the sale of x bags of corn. How many bags will give him the maximum profit?

- A. 4 B. 5
C. 6 D. 7

21. Solve the inequality $2 - x > x^2$

- A. $x < -2$ or $x > 1$ B. $x > 2$ or $x < -1$
C. $-1 < x < 2$ D. $-2 < x < 1$

22. If a and b are the roots of the equation $3x^2 + 5x - 2 = 0$, find the value of $1/a + 1/b$

- A. $-5/2$ B. $-2/3$
C. $1/2$ D. $5/2$

23. Find the minimum value of the function $f(\theta) = 2/3 - \cos\theta$ for $0 \leq \theta \leq 2\pi$.

- A. $1/2$ B. $2/3$
C. 1 D. 2

24. A frustum of a pyramid with square base has its upper and lower sections as squares of sizes 2m and 5m respectively and the distance between them 6m. find the height of the pyramid from which the frustum was obtained.

- A. 8.0m B. 8.4m
C. 9.0m D. 10.0m

25. P is a point on one side of the straight line UV and P moves in the same direction as UV. If the straight line ST is on the locus of P and $\angle VUS = 50^\circ$, find $\angle UST$.

- A. 310° B. 130°
C. 80° D. 50°

26. A ship sails a distance of 50km in the direction S50E and then sails a distance of 50km in the direction N40E. find the bearing of the ship from its original position.
- A. S90°E B. N40°E
C. S95°E D. N85°E

27. An equilateral triangle of side $\sqrt{3}$ cm is inscribed in a circle. Find the radius of the circle.
- A. $\frac{2}{3}$ cm B. 2cm
C. 1cm D. 3cm

28. $3y = 4x - 1$ and $Ky = x + 3$ are equations of two straight lines. If the two lines are perpendicular to each other, find K
- A. $-\frac{4}{3}$ B. $-\frac{3}{4}$
C. $\frac{3}{4}$ D. $\frac{4}{3}$

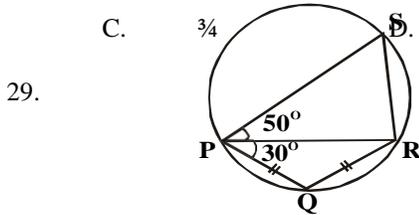

In the diagram above, if $\angle RPS = 50^\circ$, $\angle RPQ = 30^\circ$ and $PQ = QR$, find the value of $\angle PRS$

- A. 80° B. 70°
C. 60° D. 50°

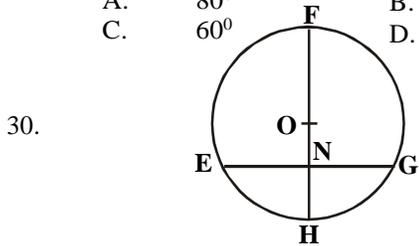

In the diagram above, EFGH is a circle center O. FH is a diameter and GE is a chord which meets FH at right angle at the point N. if $NH = 8$ cm and $EG = 24$ cm, calculate FH.

- A. 16cm B. 20cm
C. 26cm D. 32cm

31. If P and Q are fixed points and X is a point which moves so that $XP = XQ$, the locus of X is
- A. a straight line B. a circle
C. the bisector $\angle PXQ$ D. the perpendicular bisector of PQ

32. In a regular polygon, each interior angle doubles its corresponding exterior angle. Find the number of sides of the polygon.
- A. 87 B. 6
C. 4 D. 3

33. A predator moves in a circle of radius $\sqrt{2}$ centre (0, 0), while a prey moves along the line $y = x$. if $0 \leq x \leq 2$, at which point(s) will they meet?
- A. (1, 1) only B. (1, 1) and (1, 2)

34.

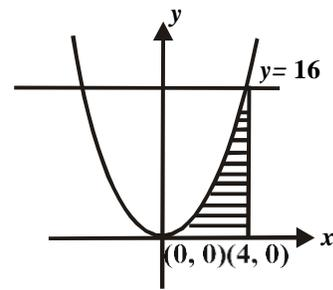

If the diagram above is the graph of $y = x^2$, the shaded area is

- A. 64 square units B. $\frac{128}{3}$ square units
C. $\frac{64}{3}$ square units D. 32 square units

35. Find the value of $\int_0^\pi (\cos^2\theta - 1/\sin^2\theta) d\theta$

- A. π B. $\frac{\pi}{0}$
C. $-\frac{\pi}{0}$ D. π

36. If $y = 2y \cos 2x - \sin 2x$, find dy/dx when $x = \pi/4$

- A. π B. $-\pi$
C. $\pi/2$ D. $-\pi/2$

37. A bowl is designed by revolving completely the area enclosed by $y = x^2 - 1$, $y = 0$, $y = 3$ and $x = 0$ around the y-axis. What is the volume of this bowl?

- A. 7π cubic units. B. $15\pi/2$ cubic units
C. 8π cubic units D. $17\pi/2$ cubic units.

38. If the volume of a hemisphere is increasing at a steady rate of $8\pi m^3 s^{-1}$, at what rate is its radius changing when it is 6m?

- A. $2.50ms^{-1}$ B. $2.00ms^{-1}$
C. $0.25ms^{-1}$ D. $0.20ms^{-1}$

39. A function $f(x)$ passes through the origin and its first derivative is $3x + 2$. what is $f(x)$

- A. $y = \frac{3}{2}x^2 + 2x$ B. $y = \frac{3}{2}x^2 + x$
C. $y = 3x^2 + x/2$ D. $y = 3x^2 + 2x$

40. The expression $ax^2 + bx + c$ equals 5 at $x = 1$. if its derivative is $2x + 1$, what are the values of a, b, c, respectively?

- A. 1, 3, 1 B. 1, 2, 1
C. 2, 1, 1 D. 1, 1, 3

41. X and Y are two events. The probability of X and Y is 0.7 and the probability of X is 0.4. If X and Y are independent, find the probability of Y.

- A. 0.30 B. 0.50
C. 0.57 D. 1.80

42. If the mean of the numbers 0, $x + 2$, $3x + 6$ and $4x + 8$ is 4, find their mean deviation.

- A. 0 B. 2
C. 3 D. 4

43. In how many ways can the word MATHEMATICS be arranged?

- A. $11!/9! 2!$ B. $11!/9! 2! 2!$
C. $11!/2! 2! 2!$ D. $11!/2! 2!$

No.	1	2	3	4	5	6
Frequency	30	43	54	40	41	32

44. A dice is rolled 240 times and the result depicted in the table above. If a pie chart is constructed to represent the data, the angle corresponding to 4 is
 A. 10° B. 16°
 C. 40° D. 60°

45. If $U = \{x : x \text{ is an integer and } \{1 \leq x \leq 20\}$
 $E_1 = \{x : x \text{ is a multiple of } 3\}$
 $E_2 = \{x : x \text{ is a multiple of } 4\}$
 And an integer is picked at random from U, find the probability that it is not in E_2
 A. $\frac{3}{4}$ B. $\frac{3}{10}$
 C. $\frac{1}{4}$ D. $\frac{1}{20}$

46.

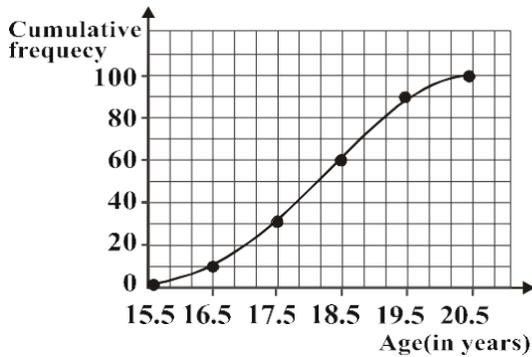

The cumulative frequency curve above represents the ages of students in a school. Which are group do 70% of the students belong?

- A. 15.5 – 18.5 B. 15.5 – 19.5
 C. 16.5 – 19.5 D. 17.5 – 20.5

47. The variance of $x, 2x, 3x, 4x$ and $5x$ is
 A. $x\sqrt{2}$ B. $2x^2$
 C. x^2 D. $3x$

48. Find the sum of the range and the mode of the set of numbers 10, 5, 10, 9, 8, 7, 7, 10, 8, 10, 8, 4, 6, 9, 10, 9, 10, 9, 7, 10, 6, 5
 A. 16 B. 14
 C. 12 D. 10

49. In how many ways can a delegation of 3 be chosen from among 5 men and 3 women, if at least one man at least one woman must be included?
 A. 15 B. 28
 C. 30 D. 45

50.

Interval (years)	10-12	13-15	16-18	19-20	21-23
No. Of Pupils	6	14	15	10	5

The table above shows the frequency distribution of the ages (in years) of pupils in a certain secondary school. What percentage of the total number of pupils is over 15 years but less than 21 years?

- A. 35% B. 45%
 C. 50% D. 60%

Mathematics 2001

- Find the principal which amounts to #5,000 at simple interest in 5 years at 2% per annum
 A. #5000 B. #4900
 C. #4800 D. #4700
- A car dealer bought a second-hand car for #250,000.00 and spent #70 000.00 refurbishing it. He then sold the car for #400 000.00. what is the percentage gain?
 A. 20% B. 25%
 C. 32% D. 60%
- Evaluate $21.05347 - 1.6324 \times 0.43$, to 3 decimal places.
 A. 20.351 B. 20.352
 C. 20.980 D. 20.981
- Evaluate $(0.14)^2 \times 0.275 / 7(0.02)$ correct to 3 decimal places
 A. 0.033 B. 0.039
 C. 0.308 D. 0.358
- Given that $p = 1 + \sqrt{2}$ and $q = 1 - \sqrt{2}$, evaluate $(p^2 - q^2) / 2pq$
 A. $-2(2 + \sqrt{2})$ B. $2(2 + \sqrt{2})$
 C. $-2\sqrt{2}$ D. $2\sqrt{2}$

- If $y/2 = x$, evaluate $(x^3/y^3 + 1/2) + (1/2 - x^2/y^2)$
 A. 5/16 B. 5/8
 C. 5/4 D. 5/2
- Simplify $(3\sqrt{64a^3})^{-3}$
 A. 8a B. 4a
 C. 1/4a D. 1/4a
- Factorize $4x^2 - 9y^2 + 20x + 25$
 A. $(2x-3y)(2x+3y)$ B. $(2x+5)(2x-9y+5)$
 C. $(2x-3y+5)(2x-3y-5)$
 D. $(2x-3y)(2x+3y+5)$
- If two graphs $y = px^2$ and $y = 2x^2 - 1$ intersect at $x = 2$, find the value of p in terms of q
 A. $(7+q)/8$ B. $(8-q)/2$
 C. $(q-8)/7$ D. $7/(q-1)$
- Solve the equations: $m^2 + n^2 = 29; m + n = 7$
 A. (5, 2) and (5, 3) B. (5, 3) and (3, 5)
 C. (2, 3) and (3, 5) D. (2, 5) and (5, 2)
- Divide $a^{3x} - 26a^{2x} + 156a^x - 216$ by $a^{2x} - 24a^x + 108$

- A. $a^x - 18$
C. $a^x - 2$

- B. $a^x - 6$
D. $a^x + 2$

- A. 4
C. -4

- B. -2
D. -12

12. Find the integral values of x and y satisfying the inequality $3y + 5x \leq 15$, given that $y > 0, y < 3$ and $x > 0$.
A. (1, 1), (2, 1), (1, 3) B. (1, 1), (1, 2), (1, 3)
C. (1, 1), (1, 2), (2, 1) D. (1, 1), (3, 1), (2, 2)

13.

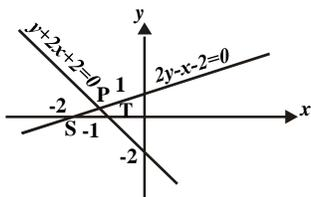

Triangle SPT is the solution of the linear inequalities

- A. $2y - x - 2 \leq 0, y + 2x + 2 \leq 0, x \geq 0, x \leq 0$
B. $2y - x - 2 \leq 0, y + 2x + 2 \leq 0, x \leq 0$
C. $2y - x - 2 \leq 0, y + 2x + 2 \leq 0, x \leq 0, x \leq -1$
D. $-2y < x \leq 2 \leq 0, y + 2x + 2 \leq 0, x \leq 0$

14. The sixth term of an arithmetic progression is half of its twelfth term. The first term is equal to
A. half of the common difference
B. double of the common difference
C. the common difference D. zero

15. A man saves #100.00 in his first year of work and each year saves #20.00 more than in the preceding year. In how many years will he save #580.00
A. 20 years B. 29 years
C. 58 years D. 100 years

16. An operation * is defined on the set of real numbers by $a*b = a + b + 1$. if the identity elements is -1, find the inverse of the element 2 under.
A. -4 B. 2
C. 0 D. 4

17

\otimes	k	l	m
k	l	m	k
l	m	k	l
m	k	l	m

The identity element with respect to the multiplication shown in the table above is

- A. k B. l
C. m D. o

18. Given that matrix $k = \begin{pmatrix} 2 & 1 \\ 3 & 4 \end{pmatrix}$ the matrix $k^2 + k + I$, where I is the 2×2 identity matrix, is
A. (9, 8) B. (10, 7)
(22, 23) (21, 24)
C. (7, 2) D. (6, 3)
(12, 21) (13, 20)

19.

Evaluate $\begin{vmatrix} -1 & -1 & -1 \\ 3 & 1 & 1 \\ 1 & 2 & 1 \end{vmatrix}$

20. If $P = \begin{vmatrix} 3 & -3 & 4 \\ 5 & 0 & 6 \\ 1 & 2 & 1 \end{vmatrix}$ then $-2p$ is

A. $\begin{vmatrix} -6 & 4 & -8 \\ 5 & 0 & 6 \\ 7 & 5 & -1 \end{vmatrix}$ B. $\begin{vmatrix} -6 & 4 & -8 \\ -10 & 0 & 6 \\ -14 & 5 & -1 \end{vmatrix}$

C. $\begin{vmatrix} -6 & -4 & 2 \\ -10 & -2 & -12 \\ -14 & 10 & 2 \end{vmatrix}$ D. $\begin{vmatrix} 6 & 4 & -8 \\ -10 & 0 & -12 \\ -14 & 40 & 2 \end{vmatrix}$

21. Find the number of sides of a regular polygon whose interior angle is twice the exterior angle
A. 2 B. 3
C. 6 D. 8

22.

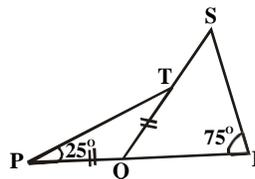

In the figure above, PQR is a straight line segment, $PQ = QT$. Triangle PQT is an isosceles triangle, $\angle SRQ$ is 75° and $\angle QPT = 25^\circ$. calculate the value of $\angle RST$.

- A. 25° B. 45°
C. 50° D. 55°

23. A cylindrical tank has a capacity of $3080m^3$. what is the depth of the tank if the diameter of its base is 14m?
A. 20m B. 22m
C. 23m D. 25m

24. A sector of a circle of radius 7.2 cm which subtends an angle 300° at the centre is used to form a cone. What is the radius of the base of the cone?
A. 6cm B. 7cm
C. 8cm D. 9cm

25. The chord ST of a circle is equal to the radius, r of the circle. Find the length of arc ST.
A. $\pi/2$ B. $\pi/3$
C. $\pi/6$ D. $\pi/12$

26. A point P moves such that it is equidistant from the points Q and R. find QR when $PR = 8cm$ and $\angle PRQ = 30^\circ$
A. 4cm B. $4\sqrt{3}cm$
C. 8cm D. $8\sqrt{3}cm$

27. Find the locus of a point which moves such that its distance from the line $y = 4$ is a constant, k.
A. $y = 4 + k$ B. $y = k - 4$
C. $y = k \pm 4$ D. $y = 4 \pm k$

28. A straight line makes an angle of 30° with the positive x-axis and cuts the y-axis at $y = 5$. find the equation of the straight line.

- A. $\sqrt{3}y = x + 5\sqrt{3}$ B. $\sqrt{3}y = -x + 5\sqrt{3}$
 C. $y = x + 5$ D. $y = 1/10x + 5$

40.

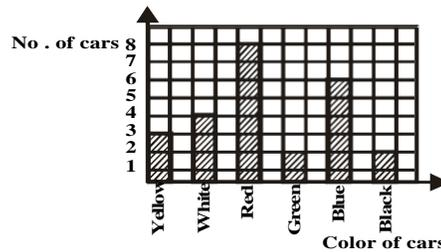

The bar chart above shows different colours of cars passing a particular point of a certain street in two minutes. What fraction of the total number of cars is yellow?

- A. $4/15$ B. $1/5$
 C. $3/25$ D. $2/25$

29. P(-6, 1) and Q(6, 6) are the two ends of the diameter of a given circle. Calculate the radius
 A. 3.5 units B. 6.5 units
 C. 7.0 units D. 13.0 units

30. Find the value of p if the line joining (p, 4) and (6, -2) is perpendicular to the line joining (2, p) and (-1, 3)
 A. 0 B. 3
 C. 4 D. 6

31. The bearing of P and Q from a common point N are 020° and 300° respectively. If P and Q are also equidistant from N, find the bearing of P from Q.
 A. 320° B. 280°
 C. 070° D. 040°

41.

32.

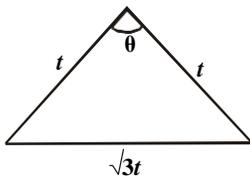

Find the value of θ in the diagram above.

- A. 30° B. 60°
 C. 100° D. 120°

33. Differentiate $(2x + 5)^2(x - 4)$ with respect to x
 A. $(2x + 5)(6x - 11)$ B. $(2x + 5)(2x - 13)$
 C. $4(2x + 5)(x - 4)$ D. $4(2x + 5)(4x - 3)$

34. If $y = x \sin x$, find dy/dx when $x = \pi/2$
 A. $\pi/2$ B. 1
 C. -1 D. $\pi/-2$

35. If the gradient of the curve $y = 2kx^2 + x + 1$ at $x = 1$ find k
 A. 1 B. 2
 C. 3 D. 4

36. Find the rate of change of the volume V of a sphere with respect to its radius r when $r = 1$
 A. 4π B. 8π
 C. 12π D. 24π

37. Find the dimensions of the rectangle of greatest area which has a fixed perimeter p.
 A. Square of sides $p/4$ B. Square of sides $p/2$
 C. Square of sides p D. Square of sides $2p$

38. Evaluate $\int 2(2x - 3)^{2/3} dx$
 A. $2x - 3 + k$ B. $2(2x - 3) + k$
 C. $6/5(2x - 3)^{5/3} + k$ D. $3/5(2x - 3)^{5/3} + k$

39. Find the area bounded by the curves $y = 4 - x^2$
 A. $10^{1/3}$ sq. units B. $10^{2/3}$ sq. units
 C. $20^{1/3}$ sq. units D. $20^{2/3}$ sq. units

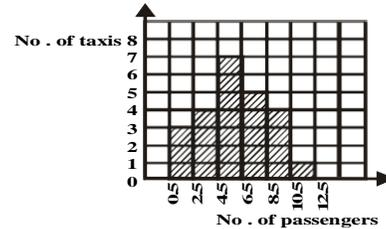

The histogram above shows the distribution of passengers in taxis of a certain motor park. How many taxis have more than 4 passenger?

- A. 14 B. 15
 C. 16 D. 17

Using the table below to answer questions 42 and 43

Score	4	7	8	11	13	8
Frequency	3	5	2	7	2	1

42.

Find the square of the mode

- A. 25 B. 49
 C. 64 D. 121

43.

The mean score is

- A. 11.0 B. 9.5
 C. 8.7 D. 7.0

44.

Find the range of $1/6$, $1/3$, $3/2$, $2/3$, $8/9$ and $4/3$

- A. $4/3$ B. $7/6$
 C. $5/6$ D. $3/4$

45.

Find the variance of 2, 6, 8, 6, 2 and 6

- A. $\sqrt{5}$ B. $\sqrt{6}$
 C. 5 D. 6

46.

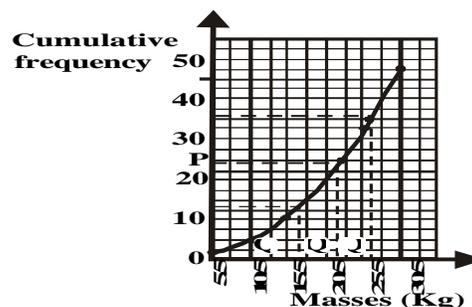

The graph above shows the cumulative frequency of the distribution of masses of fertilizer for 48 workers in one institution. Which of the following gives the interquartile range?

- A. $Q_3 - Q_1$ B. $Q_3 - Q_2$
 C. $Q_2 - Q_1$ D. $\frac{1}{2}(Q_3 - Q_1)$

47. Find the number of ways of selecting 8 subjects from 12 subjects for an examination.

- A. 498 B. 496
 C. 495 D. 490

48. If ${}^6P = 6$, find the value of 6P

- A. r 15 B. $r+1$ 30
 C. 33 D. 35

49.

Colour	Blue	Black	Yellow	White	Brown
No. of beads	1	2	4	5	3

The distribution of colors of beads in a bowl is given above. What is the probability that a bead selected at random will be blue or white?

- A. $1/15$ B. $1/3$
 C. $2/5$ D. $7/15$

50. Teams P and Q are involved in a game of football. What is the probability that the game ends in a draw?

- A. $1/4$ B. $1/3$
 C. $1/2$ D. $2/3$

Mathematics 2002

1. A trader bought goats for #4 000 each. He sold them for #180 000 at a loss of 25%. How many goats did he buy?

- A. 36 B. 45
 C. 50 D. 60

2. Simplify $(\sqrt{0.7} + \sqrt{70})^2$

- A. 217.7 B. 168.7
 C. 84.7 D. 70.7

3. Evaluate

$(0.21 \times 0.072 \times 0.0054) / (0.006 \times 1.68 \times 0.063)$
 correct to four significant figures.

- A. 0.1286 B. 0.1285
 C. 0.01286 D. 0.01285

4. In a school, 220 students offer Biology or Mathematics or both. 125 offer Biology and 110 Mathematics. How many offer Biology but not Mathematics?

- A. 125 B. 110
 C. 95 D. 80

5. Simplify $52.4 - 5.7 - 3.45 - 1.75$

- A. 42.2 B. 42.1
 C. 41.5 D. 41.4

6. Without using tables, evaluate

$(343)^{1/3} \times (0.14)^{-1} \times (25)^{1/2}$

- A. 7 B. 8
 C. 10 D. 12

7.



In the diagram below are two concentric circles of radii r and R respectively with centre O. if $r = \frac{2}{5} R$, express the area of the shaded portion in terms of π and R.

- A. $\frac{9}{25} \pi R^2$ B. $\frac{5}{9} \pi R^2$
 C. $\frac{21}{25} \pi R^2$ D. $\frac{21}{23} \pi R^2$

8. Find the value of $\&$ if the line $2y - \&x + 4 = 0$ is perpendicular to the line $y + \frac{1}{4}x - 7 = 0$

- A. -8 B. -4
 C. 4 D. 8

9. A bucket is 12cm in diameter at the top, 8cm in diameter at the bottom and 4cm deep. Calculate its volume.

- A. $144\pi\text{cm}^3$ B. $304\pi\text{cm}^3/3$
 C. $72\pi\text{cm}^3$ D. $128\pi\text{cm}^3/$

10.

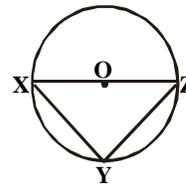

In the diagram below, XZ is the diameter of the circle XYZW, with centre O and radius $15/2\text{cm}$. If $XY = 12\text{cm}$, find the area of the triangle XYZ.

- A. 75cm^2 B. 54cm^2
 C. 45cm^2 D. 27cm^2

11. Find the coordinate of the midpoint of x and y intercepts of the line $2y = 4x - 8$

- A. (-1, -2) B. (1, 2)
 C. (2, 0) D. (1, -2)

12. A chord of a circle subtends an angle of 120° at the centre of a circle of diameter $4\sqrt{3}\text{cm}$. Calculate the area of the major sector.

- A. $32\pi\text{cm}^2$ B. $16\pi\text{cm}^2$
 C. $8\pi\text{cm}^2$ D. $4\pi\text{cm}^2$

13. If $\tan q = 4/3$, calculate $\sin^2 \theta - \cos^2 \theta$.

- A. $7/25$ B. $9/25$
 C. $16/25$ D. $24/25$

14.

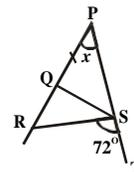

In the diagram above, PST is a straight line, $PQ = QS = RS$. If $\angle RSRT = 72^\circ$, find x .

- A. 72° B. 36°
 C. 24° D. 18°

15. The locus of a point P which is equidistant from two given points S and T is
 A. a perpendicular to ST
 B. a line parallel to ST
 C. the angle bisector of PS and ST
 D. the perpendicular bisector ST

16. A solid hemisphere has radius 7cm. Find the total surface area.
 A. 462cm^2 B. 400cm^2
 C. 308cm^2 D. 66cm^2

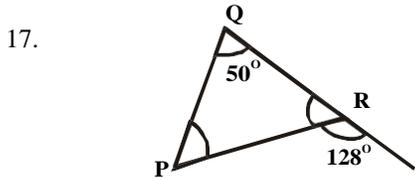

- The angle PGR below is
 A. a scalene triangle
 B. an isosceles triangle
 C. an equilateral triangle
 D. an obtuse – angled triangle

18. The sum of the interior angles of a polygon is 20 right angles. How many sides does the polygon have?
 A. 10 B. 12
 C. 20 D. 40

19. Find the equation of the set of points which are equidistant from the parallel lines $x = 1$ and $x = 7$
 A. $y = 4$ B. $y = 3$
 C. $x = 3$ D. $x = 4$

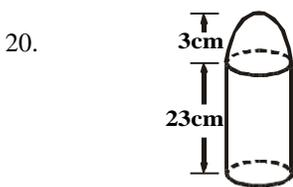

In the diagram below, a cylinder is surrounded by a hemispherical bowl. Calculate the volume of the solid.

- A. $216\pi\text{cm}^3$ B. $198\pi\text{cm}^3$
 C. $180\pi\text{cm}^3$ D. $162\pi\text{cm}^3$

21. A hunter 1.6m tall, views a bird on top of a tree at an angle of 45° . If the distance between the hunter and the tree is 10.4m, find the height of the tree.
 A. 8.8m B. 9.0m
 C. 10.4m D. 12.0m

22. The mean of a set of six numbers is 60. If the mean of the first five is 50, Find the sixth number in the set.
 A. 110 B. 105
 C. 100 D. 95

23. The range of the data $k + 2$, $k - 3$, $k + 4$, $k - 2$, k , $k - 5$, $k + 3$, $k - 1$ and $k + 6$ is.

- A. 6 B. 8
 C. 10 D. 11

24.

No . of days	1	2	3	4	5	6
No . of students	20	x	50	40	2x	60

The distribution above shows the number of days a group of 260 students were absent from school in a particular term. How many students were absent for at least four days in the term?

- A. 40 B. 120
 C. 160 D. 210

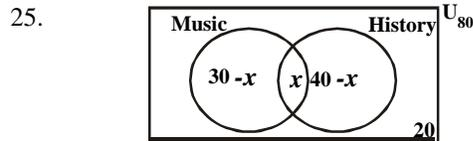

The venn diagram below shows the number of students offering Music and History in a class of 80 students. If a student is picked at random from the class, what is the probability that he offers Music only?

- A. 0.13 B. 0.25
 C. 0.38 D. 0.50

26. Find the mean of the data 7,-3,4,-2,5,-9,4,8,-6,12
 A. 1 B. 2
 C. 3 D. 4

27. The probability of a student passing any examination is $\frac{2}{3}$. If the student takes three examination, what is the probability that he will not pass any of them?

- A. $\frac{1}{27}$ B. $\frac{8}{27}$
 C. $\frac{4}{9}$ D. $\frac{2}{3}$

28. How many three-digit numbers can be formed from 32564 without digit being repeated?

- A. 10 B. 20
 C. 60 D. 120

29. The acres for rice, principle, cassava, cocoa and palm oil, in a certain district are given respectively as 2,5,3, 11 and 9. what is the angle of the sector for cassava in a pie chart?

- A. 36° B. 60°
 C. 108° D. 180°

30. Calculate the mean deviation of the set of numbers 7,3,14,9,7 and 8

- A. $2\frac{1}{2}$ B. $2\frac{1}{3}$
 C. $2\frac{1}{6}$ D. $1\frac{1}{6}$

31. Find the maximum value of y in the equation $y = 1 - 2x - 3x^2$

- A. $\frac{5}{3}$ B. $\frac{4}{3}$
 C. $\frac{5}{4}$ D. $\frac{3}{4}$

32. If the 9th term of an A. P is five times the 5th term, find the relationship between a and d.

A. $a + 2d = 0$
C. $3a + 5d = 0$

B. $a + 3d = 0$
D. $2a + d = 0$

C. $\begin{vmatrix} (-3,0) \\ (0 -3) \end{vmatrix}$

D. $\begin{vmatrix} (9, 4) \\ (12, 1) \end{vmatrix}$

33. The time taken to do a piece of work is inversely proportional to the number of men employed. If it takes 45 men to do a piece of work in 5 days, how long will take 25 men?

- A. 5 days
B. 9 days
C. 12 days
D. 15 days

34. The binary operation is defined on the set of integers p and q by $p * q = pq + p + q$. find $2(3 * 4)$

- A. 19
B. 38
C. 59
D. 67

35. If -2 is the solution of the equation $2x + 1 - 3c = 2c + 3x - 7$, find the value of c.

- A. 1
B. 2
C. 3
D. 4

36. If $N = \begin{vmatrix} 3 & 5 & -4 \\ 6 & -3 & -5 \\ -2 & 2 & 1 \end{vmatrix}$ find $|N|$

- A. 91
B. 65
C. 23
D. 17

37. Use the graph below to find the values of p and q if $px + qy < 4$

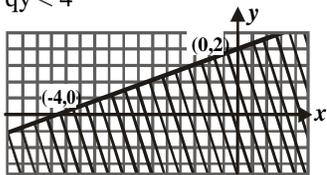

- A. $p = 1, q = 2$
B. $p = 2, q = 1$
C. $p = -1, q = 2$
D. $p = 2, q = -1$

38. The inverse of the function $f(x) = 3x + 4$ is

- A. $1/3(x + 4)$
B. $1/4(x + 3)$
C. $1/5(x - 5)$
D. $1/3(x - 4)$

39. Solve for x in the equation

$x^3 - 5x^2 - x + 5 = 0$

- A. 1, 1 or 5
B. -1, 1 or -5
C. 1, 1 or -5
D. 1, -1 or 5

40. If $P = \begin{vmatrix} (2, 1) \\ (-3, 0) \end{vmatrix}$ and I is a 2×2 unit matrix, evaluate $P^2 - 2P + 4I$

- A. $\begin{vmatrix} (2, 1) \\ (4, 1) \end{vmatrix}$
B. $\begin{vmatrix} (1, 0) \\ (0, 1) \end{vmatrix}$

41. Find the range of values of x for which $x + 2/4 - 2x - 3/3 < 4$

- A. $x > -3$
B. $x < 4$
C. $x > -6$
D. $x < 8$

42. If x varies directly as \sqrt{n} and $x = 9$ when $n = 9$, find x when $n = 17/9$

- A. 27
B. $\sqrt{17}$
C. 4
D. $\sqrt{3}$

43. The sum of infinity of the series

$1 + 1/3 + 1/9 + 1/27 + \dots$ is

- A. 3/2
B. 5/2
C. 10/3
D. 11/3

44. Make r the subject of the formula

$x/r + a = a/r$

- A. $a/(x - a)$
B. $(a/x + a)$
C. $a^2/(x - a)$
D. $a^2/(x + a)$

45. If $y = x^2 - 1/x$, find dy/dx

- A. $2x + x^2$
B. $2x - x^2$
C. $2x - 1/x^2$
D. $2x - 1/x^2$

46. Evaluate $\int \sin 3x dx$

- A. $-2/3 \cos 3x + c$
B. $-1/3 \cos 3x + c$
C. $1/3 \cos 3x + c$
D. $2/3 \cos 3x + c$

47. A circle with a radius 5cm has its radius increasing at the rate of 0.2cms-1. what will be the corresponding increase in the area?

- A. 5p
B. 4p
C. 2p
D. p

48. If $dy/dx = 2x - 3$ and $y = 3$ when $x = 0$, find y in terms of x.

- A. $x^2 - 3x$
B. $x^2 - 3x + 3$
C. $2x^2 - 3x$
D. $x^2 - 3x - 3$

49. Find the derivative of $y = \sin^2(5x)$ with respect to x

- A. $2 \sin 5x \cos 5x$
B. $5 \sin 5x \cos 5x$
C. $10 \sin 5x \cos 5x$
D. $15 \sin 5x \cos 5x$

50. The slope of the tangent to the curve $y = 3x^2 - 2x + 5$ at the point (1, 6) is

- A. 1
B. 4
C. 5
D. 61.

Mathematics 2003

1. Simplify $1 - (2^{1/3} 1^{1/3})_4 + 3/5$

- A. $-2^{31}/60$
B. $-2^7/15$
C. $-1^{19}/60$
D. $-1^{1/15}$

- A. 133
B. 113
C. 63
D. 84

2. A cinema hall contains a certain number of people. If $22\frac{1}{2}\%$ are children, $47\frac{1}{2}\%$ are men and 84 are women, find the number of men in the hall.

3. Simplify $213_4 \times 23_4$

- A. 13211_4
B. 10311_4
C. 10321_4
D. 12231_4

4. A woman buys 270 oranges for # 1800.00 and sells at 5 for #40.00. what is her profit?

- A. #630.00 B. #360.00
C. #1620.00 D. #2160.00

5. Simplify $\frac{\sqrt{98} - \sqrt{50}}{\sqrt{32}}$

- A. $\frac{1}{2}$ B. $\frac{1}{4}$
C. 1 D. 3

6. The sum of four numbers is 1214₅, what is the average expressed in base five?

- A. 411 B. 401
C. 141 D. 114

7. Evaluate $\log_{\frac{1}{2}}4 + \log_{\frac{1}{2}}16 - \log_432$

- A. -2.5 B. 5.5
C. -5.5 D. 2.5

8. Given:

U = {Even numbers between 0 and 30}

P = {Multiples of 6 between 0 and 30}

Q = {Multiples of 4 between 0 and 30}

Find (PUQ)^c.

- A. {0,2,6,22,26} B. {2,4,14,18,26}
C. {2,10,14,22,26} D. {0,10,14,22,26}

9. In a class of 40 students, 32 offer Mathematics, 24 offer Physics and 4 offer neither Mathematics nor Physics. How many offer both Mathematics and Physics?

- A. 16 B. 4
C. 20 D. 8

10. Find $(1/0.06 \div 1/0.042)^{-1}$, correct to two decimal places

- A. 4.42 B. 3.14
C. 1.53 D. 1.43

11. If $9^{2x-1}/27^{x+1} = 1$, find the value of x.

- A. 2 B. 8
C. 5 D. 3

12. Factorize completely

$4abx - 2axy - 12b^2x + 6bx^2$

- A. $2x(3b-a)(2b-y)$ B. $2x(a-3b)(b-2y)$
C. $2x(2b-a)(3b-y)$ D. $2x(a-3b)(2b-y)$

13. The sum of the first n terms of an arithmetic progression is 252. if the first term is -16 and the last term is 72, find the number of terms in the series.

- A. 7 B. 9
C. 6 D. 8

14. The graphs of the function $y = x^2 + 4$ and a straight line PQ are drawn to solve the equation $x^2 - 3x + 2 = 0$. what is the equation of PQ?

- A. $y = 3x + 2$ B. $y = 3x - 4$
C. $y = 3x + 4$ D. $y = 3x - 2$

15. A matrix P has an inverse $P^{-1} = (1-3)$

(0, 1) Find P.

- A. $\begin{pmatrix} 1 & 3 \\ 0 & 1 \end{pmatrix}$

- B. $\begin{pmatrix} 1 & -3 \\ 0 & -1 \end{pmatrix}$

- C. $\begin{pmatrix} 1 & 3 \\ 0 & -1 \end{pmatrix}$

- D. $\begin{pmatrix} -1 & 3 \\ 0 & -1 \end{pmatrix}$

16. Find the values of x and y respectively if $3x - 5y + 5 = 0$ and $4x - 7y + 8 = 0$

- A. -4, -5 B. -5, -4
C. 5, 4 D. 4, 5

17. If $\begin{vmatrix} (x, 2) & (3, 3x) \\ (4x, 1) & (4, -5) \end{vmatrix}$ find the value of x

- A. -2 B. -5
C. 2 D. 5

18. Find the range of values of x satisfying the inequalities $5 + x \leq 8$ and $13 + 3x \leq 7$.

- A. $-6 \leq x \leq 3$ B. $-6 \leq x \leq -3$
C. $3 \leq x \leq 6$ D. $-3 \leq x \leq 3$

19. x varies directly as the product of U and V and inversely as their sum. If $x = 3$ when $U = 3$ and $V = 1$, what is the value of x if $U = 3$ and $V = 3$?

- A. 4 B. 9
C. 6 D. 3

20.

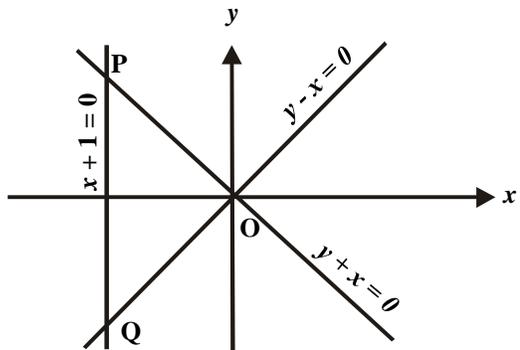

Triangle OPQ above is the solution of the inequalities.

- A. $x - 1 \leq 0, y + x \leq 0, y, -x \leq 0$
B. $x + 1 \geq 0, y + x \leq 0, y, -x \geq 0$
C. $y + x \leq 0, y - x \geq 0, x - 1 \geq 0$
D. $x - 1 \leq 0, y - x \geq 0, y + x \geq 0$

21. Three consecutive terms of a geometric progression are given as $n - 2, n$ and $n + 3$. find the common ratio.

- A. $\frac{2}{3}$ B. $\frac{3}{2}$
C. $\frac{1}{2}$ D. $\frac{1}{4}$

22. The length a person can jump is inversely proportional to his weight. If a 20kg person can jump 1.5 m, find the constant of proportionality.

- A. 30 B. 60
C. 15 D. 20

23.

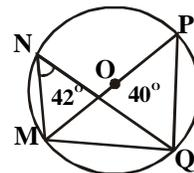

In the diagram above, O is the centre of the circle, POM is a diameter and $\angle MNQ = 42^\circ$. calculate $\angle QMP$.

- A. 138° B. 132°
 C. 42° D. 48°

24. The locus of a point P which moves on one side only of a straight line XY so that $\angle XPY = 90^\circ$ is.
 A. the perpendicular bisector of XY
 B. a circle C. a semicircle
 D. an arc of a circle through X, Y

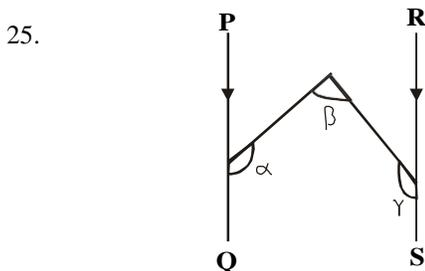

In the diagram above, PQ is parallel to RS. What is the value of $\alpha + \beta + \gamma$?

- A. 180° B. 90°
 C. 200° D. 360°

26. Which of the following is the graph of $\sin \theta$ for $-\frac{\pi}{2} \leq \theta \leq \frac{3\pi}{2}$

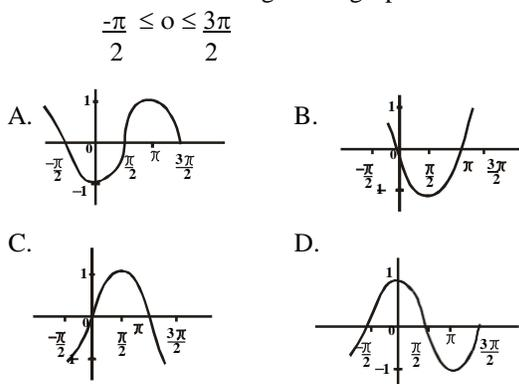

- 27.

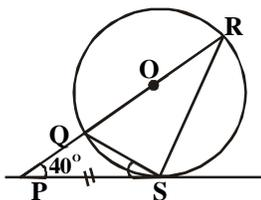

In the diagram above, PQR is a straight line and PS is a tangent to the circle QRS with $\angle PSQ = \angle SRP$ and $\angle SPR = 40^\circ$. find $\angle PSQ$.

- A. 20° B. 10°
 C. 40° D. 30°

28. If $\pi/2 \leq \theta \leq 2\pi$, find the maximum value of $f(\theta) = 4/6 + 2 \cos \theta$

- A. 1 B. $1/2$
 C. 4 D. $2/3$

29. An aeroplane flies due north from airports P to Q and then flies due east to R. if Q is equidistant from P and R, find the bearing of P and R.

- A. 270° B. 090°
 C. 135° D. 225°

30. Find the value of p, if the line of which passes through $(-1, -p)$ and $(-2, 2)$ is parallel to the line $2y + 8x - 17 = 0$.

- A. $-2/7$ B. $7/6$
 C. $-6/7$ D. $6/7$

31. Find the equation of the locus of a point P(x, y) which is equidistant from Q(0,0) and R(2, 1).

- A. $2x + y = 5$ B. $2x + 2y = 5$
 C. $4x + 2y = 5$ D. $4x - 2y = 5$

32. An arc of a circle subtends an angle of 30° on the circumference of a circle of a radius 21cm. Find the length of the arc

- A. 66cm B. 44cm
 C. 22cm D. 11cm

33. A trapezium has two parallel sides of length 5cm and 9cm. If the area is 121cm^2 , find the distance between the parallel sides.

- A. 7cm B. 3cm
 C. 4cm D. 6cm

- 34.

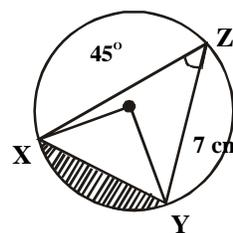

XYZ is a circle centre O and radius 7cm. Find the area of the shaded region.

- A. 14cm^2 B. 38cm^2
 C. 77cm^2 D. 84cm^2

35. A triangle has vertices P(-1, 6), Q(-3, -4) and R(1, -4). Find the midpoints of PQ and QR respectively.

- A. $(-1, 0)$ and $(-1, -1)$ B. $(-2, 1)$ and $(-1, -4)$
 C. $(0, -1)$ and $(-1, -4)$ D. $(-2, 1)$ and $(0, 1)$

36. Evaluate $\int_2^3 (x^2 - 2x) dx$

- A. $4/3$ B. $1/3$
 C. 2 D. 4

37. If $y = 3 \sin(-4x)$, dy/dx is

- A. $-12 \cos(-4x)$ B. $12 \sin(-4x)$
 C. $12x \cos(4x)$ D. $-12x \cos(-4x)$

38. Determine the maximum value of $y = 3x^2 + 5x - 3$ at

- A. 6 B. 0
 C. 2 D. 4

39. Find the slope of the curve $y = 2x^2 + 5x - 3$ at (1, 4).

- A. 7 B. 9
C. 4 D. 6

- A. #48.00 B. #96.00
C. #42.00 D. #84.00

40. No of people

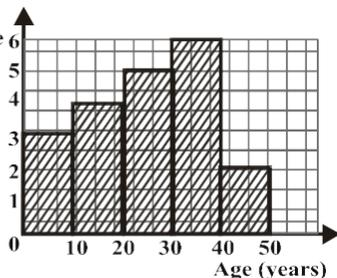

The histogram above shows the ages of the victims of a pollution. How many people were involved in the pollution?

- A. 18 B. 21
C. 15 D. 20

45. The range of 4, 3, 11, 9, 6, 15, 19, 23, 27, 24, 21 and 16 is
A. 23 B. 24
C. 21 D. 16

46.

Number	1	2	3	4	5	6
Frequency	12	20	x	21	x-1	28

The result of tossing a fair die 120 times is summarized above. Find the value of x.

- A. 21 B. 19
C. 22 D. 20

47. If ${}^n P_3 - 6({}^n C_4) = 0$, find the value of n
A. 6 B. 5
C. 8 D. 7

48. Two dice are thrown. What is the probability that the sum of the numbers is divisible by 3.
A. $\frac{1}{2}$ B. $\frac{1}{3}$
C. $\frac{1}{4}$ D. $\frac{1}{6}$

41. Find the mean of the distribution above.

Value	1	2	3	4	5	6
Frequency	1	4	2	2	1	9

42. The mean of the numbers 3, 6, 4, x and 7 is 5. find the standard deviation
A. 2 B. 3
C. $\sqrt{3}$ D. $\sqrt{2}$

49. Find the number of committees of three that can be formed consisting of two men and one woman from four men and three women.
A. 24 B. 18
C. 3 D. 6

43. A bag contains 5 black ball and 3 red balls. Two balls are picked at random without replacement. What is the probability that a black and a red balls are picked?
A. $\frac{5}{14}$ B. $\frac{13}{28}$
C. $\frac{3}{14}$ D. $\frac{15}{28}$

50. By how much is the mean of 30, 56, 31, 55, 43 and 44 less than the median.
A. 0.50 B. 0.75
C. 0.17 D. 0.33

44. On a pie chart, there are four sectors of which three angles are 45° , 90° and 135° . if the smallest sector represents #28.00, how much is the largest sector?

Mathematics 2004

- C. (0,0) and (1,1) D. $(\sqrt{2}, \sqrt{2})$ only

1. 4 2 4 3

 1 3 x 4

 y 3 4 4

Find x and y respectively in the subtraction above carried out in base 5

- A. 2, 4 B. 3, 2
C. 4, 2 D. 4, 3

2. Find p, if $451_6 - p_7 = 305_6$
A. 611_7 B. 142_7
C. 116_7 D. 62_7

3. $\frac{1}{10} \times \frac{2}{3} \div \frac{1}{4}$

$\frac{1}{2} \div \frac{3}{5} - \frac{1}{4}$

- A. $\frac{2}{25}$ B. $\frac{19}{60}$
C. $\frac{7}{12}$ D. $\frac{19}{35}$

4. A farmer planted 5000 grains of maize and harvested 5000 cobs, each bearing 500 grains. What is the ratio of the number of grains sowed to the number harvested?
A. 1:500 B. 1:5000
C. 1:25000 D. 1:250000

5. Three teachers shared a packet of chalk. The first teacher got $\frac{2}{5}$ of the chalk and the second teacher received $\frac{2}{15}$ of the remainder. What fraction did the third teacher receive?
A. $\frac{11}{25}$ B. $\frac{12}{25}$
C. $\frac{13}{25}$ D. $\frac{8}{15}$

6. Given that $3\sqrt{4^{2x}}$, find the value of x
A. 2 B. 3
C. 4 D. 6

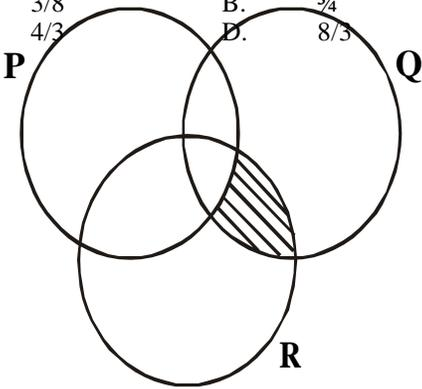
7. Simplify $1\sqrt[3]{3} + 2$ in the form $a + b\sqrt[3]{3}$
 A. $-2 - 3$ B. $-2 + 3$
 C. $2 - 3$ D. $2 + 3$
8. If $6\log_x 2 - 3\log_x 3 = 3\log_x 0.2$, find x .
 A. $\frac{3}{8}$ B. $\frac{3}{4}$
 C. $\frac{4}{3}$ D. $\frac{8}{3}$
9. 

The shaded region in the venn diagram above

- A. $P^c \cap (QR)$ B. $P \cap Q$
 C. $P^c \cup (Q \cap R)$ D. $P^c \cap (QR)$
10. In a class of 40 students, each student offers at least one of Physics and Chemistry. If the number of students that offer Physics is three times the number that offer both subjects and the number that offers Chemistry is twice the number that offer Physics, find the number of students that offer Physics only.
 A. 25 B. 15
 C. 10 D. 5
11. Find the values of x where the curve $y = x^3 + 2x^2 - 5x - 6$ crosses the x -axis.
 A. $-2, -1$ and 3 B. $-2, 1$ and -3
 C. $2, -1$ and -3 D. $2, 1$ and 3
12. Find the remainder when $3x^3 + 5x^2 - 11x + 1$ is divided by $x + 3$
 A. 4 B. 1
 C. -1 D. 4
13. Factorize completely $ac - 2bc - a^2 + 4b^2$
 A. $(a - 2b)(c + a - 2b)$
 B. $(a - 2b)(c - a - 2b)$
 C. $(a - 2b)(c + a + 2b)$
 D. $(a - 2b)(c - a + 2b)$
14. y is inversely proportional to x and $y = 4$ when $x = 1/2$. find x when $y = 10$
 A. $1/10$ B. $1/5$
 C. 2 D. 10
15. The length L of a simple pendulum varies directly as the square of its period T . if a pendulum with period 4 secs is 64cm long, find the length of a pendulum whose period is 9 sec.
 A. 36cm B. 96cm
 C. 144cm D. 324cm

16.

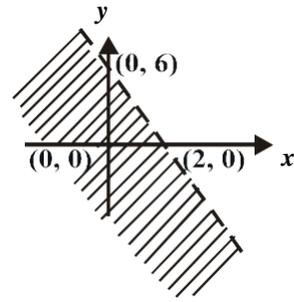

The shaded area in the diagram above is represented by

- A. $\{(x, y) : y + 3x < 6\}$
 B. $\{(x, y) : y + 3x < -6\}$
 C. $\{(x, y) : y - 3x < 6\}$
 D. $\{(x, y) : y - 3x < -6\}$
17. What are the integral values of x which satisfy the inequality $-1 < 3 - 2x \leq 5$?
 A. $-2, 1, 0, -1$ B. $-1, 0, 1, 2$
 C. $-1, 0, 1,$ D. $0, 1, 2$
18. The n th terms of two sequences are $Q_n = 3.2^{n-2}$ and $U_n = 3.2^{2m-n}$. find the product of Q_2 and U_2
 A. 3 B. 6
 C. 12 D. 18
19. Given that the first and fourth terms of a G.P are 6 and 162 respectively, find the sum of the first three terms of the progression.
 A. 8 B. 27
 C. 48 D. 78
20. Find the sum to infinity of the series $\frac{1}{2}, \frac{1}{6}, \frac{1}{18}, \dots$
 A. 1 B. $\frac{3}{4}$
 C. $\frac{2}{3}$ D. $\frac{1}{3} +$
21. If the operation $*$ on the set of integers is defined by $p*q = pq$, find the value of $4*(8*32)$.
 A. 16 B. 8
 C. 4 D. 3
22. The inverse of the matrix $\begin{pmatrix} 2 & 1 \\ 1 & 1 \end{pmatrix}$ is $\begin{vmatrix} \blacksquare & \blacksquare \\ \blacksquare & \blacksquare \end{vmatrix}$
 A. $\begin{vmatrix} (1 & 1) \\ (-1 & 2) \end{vmatrix}$ B. $\begin{vmatrix} (1 & -1) \\ (1 & 2) \end{vmatrix}$
 C. $\begin{vmatrix} (1 & 1) \\ (1 & 2) \end{vmatrix}$ D. $\begin{vmatrix} (1 & -1) \\ (-1 & 2) \end{vmatrix}$
23. If $P = \begin{vmatrix} 1 & 0 & -1 \\ 3 & 4 & 5 \\ -1 & 0 & 1 \end{vmatrix}$ then P/P is
 A. -8 B. 0
 C. 4 D. 8
24. The sum of the interior angles of a pentagon is $6x + 6y$. find y in terms of x

- A. $y = 60 - x$ B. $y = 90 - x$
 C. $y = 120 - x$ D. $y = 150 - x$

25. PQRSTV is a regular polygon of side 7cm inscribed in a circle. Find the circumference of the circle PQRSTV.
 A. 22cm B. 42cm
 C. 44cm D. 56cm

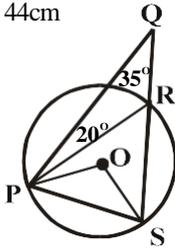

26. P, R and S lie on a circle centre O as shown above while Q lies outside the circle. Find $\angle PPSO$.
 A. 35° B. 40°
 C. 45° D. 55°

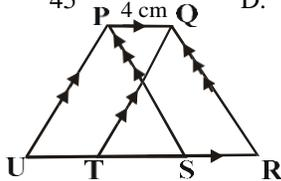

27. In the diagram above, $PQ = 4\text{cm}$ and $TS = 6\text{cm}$, if the area of parallelogram PQTU is 32cm^2 , find the area of the trapezium PQRU.
 A. 24cm^2 B. 48cm^2
 C. 60cm^2 D. 72cm^2

28. An arc of a circle of length 22cm subtends an angle of $3x^\circ$ at the centre of the circle. Find the value of x if the diameter of the circle is 14cm. which is equidistant from PQ and QR.
 A. The diagonal PR. B. The diagonal QS
 C. Side SR
 D. The perpendicular bisector of PQ.
 A. 30° B. 60°
 C. 120° D. 180°

Determine the locus of a point inside a s

30. The locus of a point which is 5cm from the line LM is a
 A. pair of lines on opposite sides of LM and parallel to it, each distances 5cm from LM
 B. line parallel to LM and 5cm from LM
 C. pair of parallel lines on one side of LM and parallel to LM
 D. line distance 10cm from LM and parallel to LM.
31. Find the value of $\alpha^2 + \beta^2$ if $a + b =$ and the distance between the points $(1, \alpha)$ and $(\beta, 1)$ is 3 units.
 A. 3 B. 5
 C. 11 D. 14
32. Find the midpoint of the line joining $P(-3, 5)$ and $Q(5, -3)$.

- A. $(4, -4)$ B. $(4, 4)$
 C. $(2, 2)$ D. $(1, 1)$

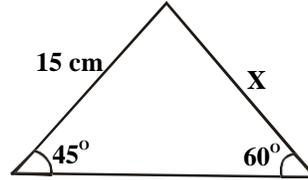

33. Find the value of x in the figure above.
 A. $20\sqrt{6}$ B. $15\sqrt{6}$
 C. $5\sqrt{6}$ D. $3\sqrt{6}$

34. The shadow of a pole $5\sqrt{3}$ m high is 5m. find the angle of elevation of the sun.
 A. 30° B. 45°
 C. 60° D. 75°

35. Find the derivative of $(2 + 3x)(1 - x)$ with respect to x
 A. $6x - 1$ B. $1 - 6x$
 C. 6 D. 3

36. Find the derivative of the function $y = 2x^2(2x - 1)$ at the point $x = -1$
 A. -6 B. 4
 C. 16 D. 18

37. If $y = 3 \cos(x/3)$, find $\frac{dy}{dx}$ when $x = 3\pi/2$
 A. 2 B. 1
 C. -1 D. 3

38. What is the rate of change of the volume v of hemisphere with respect to its radius r when $r = 2$?
 A. 2π B. 4π
 C. 8π D. 16π



- A. $6^{2/3}$ B. $2^{2/3}$
 C. $-2^{2/3}$ D. $-6^{2/3}$

40.

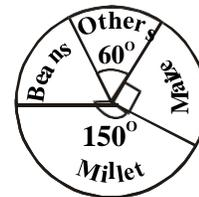

- The pie chart above shows the distribution of the crops harvested from a farmland in a year. If 3000 tonnes of millet is harvested, what amount of beans is harvested?
 A. 9000 tonnes B. 6000 tonnes
 C. 1500 tonnes D. 1200 tonnes

41. I. Rectangular bars of equal width
 II. The height of each rectangular bar is proportional to the frequency of the 3 corresponding class interval.
 III. Rectangular bars have common

